

# TRAZAR

Y RECONOCER CONSONANTES

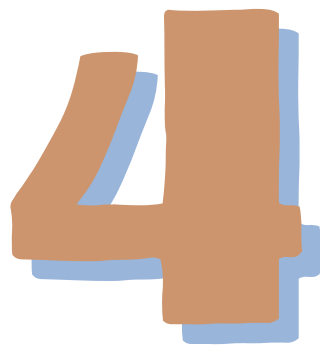

**Cuadernillo de Ejercicios**



**DIVERTI**

**LANDIA**



# Colaboraciones

Este libro ha siado creado en colaboración con  
@pintandosonrisasmexico, @clubkire, @compartiendocontigo,  
@divertilandia, @educacionconsciente, @elsalondepablo,  
@patitosfelices, @miabcedario.



Todos los derechos reservados.

# Recomendaciones

@divertilandia.digital

1. Imprime este cuadernillo en blanco y negro o a color. También puedes plastificar las hojas para hacer los ejercicios una y otra vez.
2. Enséñale a tu peque cómo sostener un bolígrafo o lápiz de manera adecuada.
3. Practica de manera conjunta. Es muy importante para los peques sentir tu apoyo a la hora de aprender algo nuevo.
4. Estos ejercicios son muy útiles para mejorar la caligrafía y comprensión lectora ya que tiene distintos tipos de actividades y están adecuados a la edad de tu hijo.
5. No te desesperes. Todo lleva su tiempo. Para que tu hijo adquiera la habilidad de leer y escribir con soltura se necesitará tiempo, horas de práctica y muchas muchas ganas.



## ¡Aprender es divertido!



52+ 969 103 0098



@divertilandia.digital



cuadernillosdemate.com 



# lectoescritura

Traza

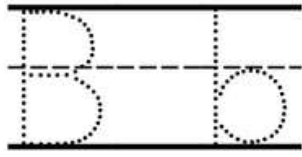

Escribe

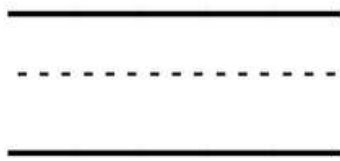

Colorea

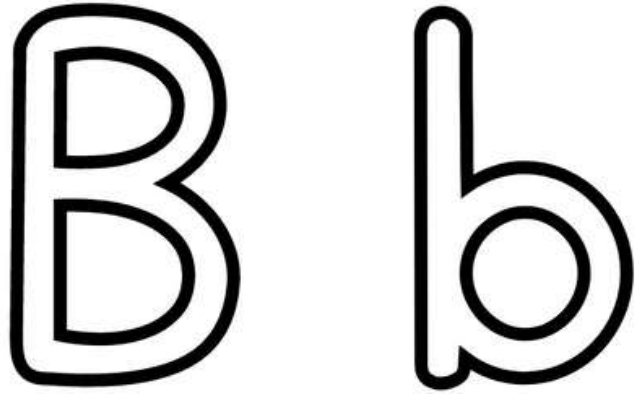

@divertilandia.digital

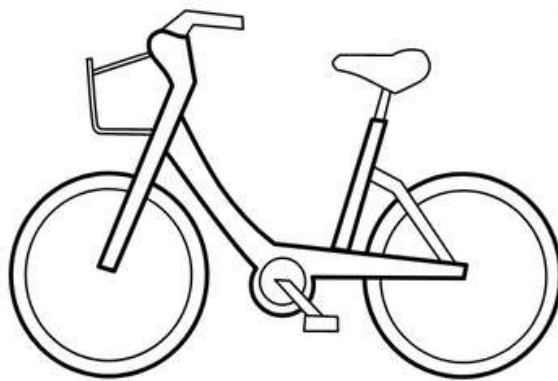
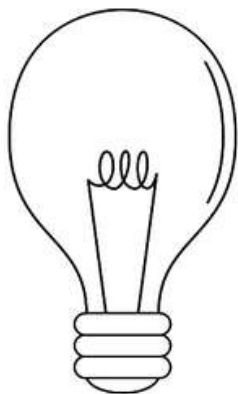
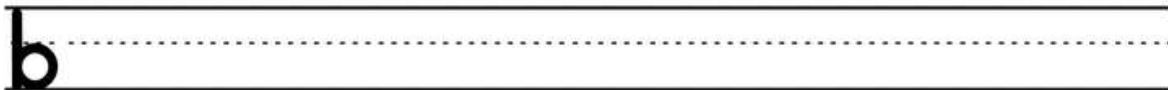
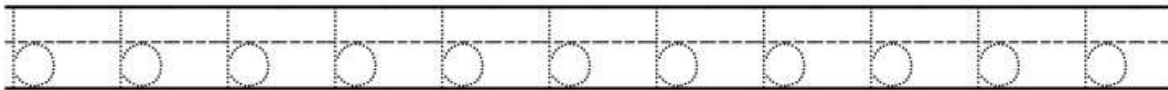
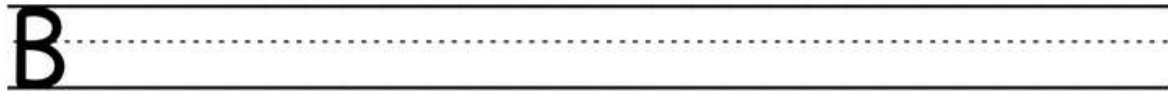
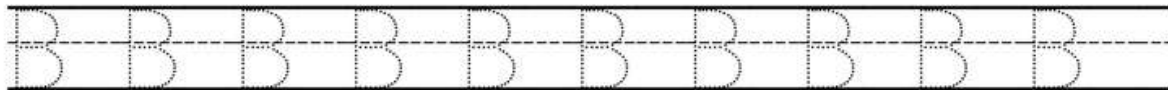

# lectoescritura

Traza

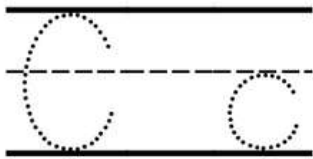

Escribe

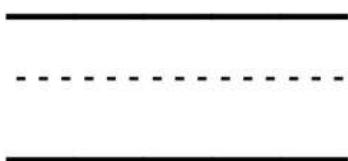

Colorea

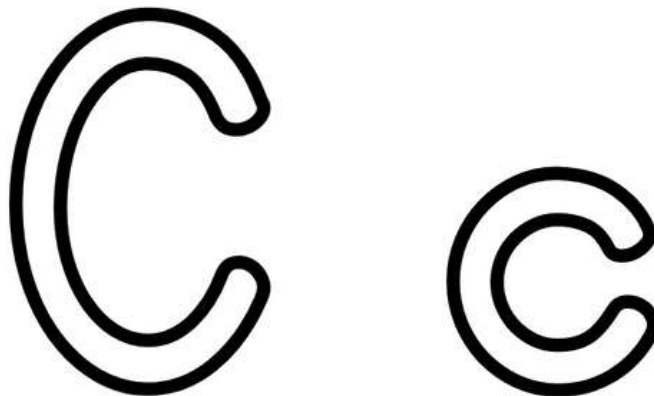

@divertilandia.digital

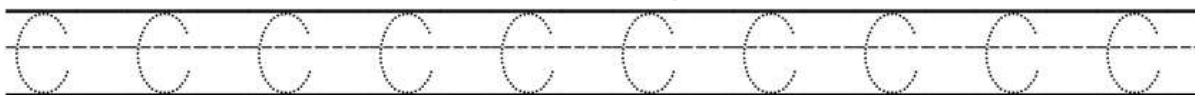

C



c

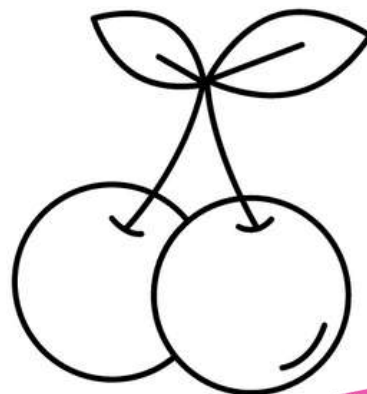
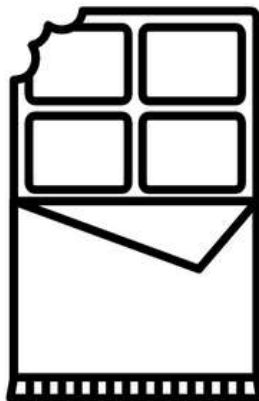
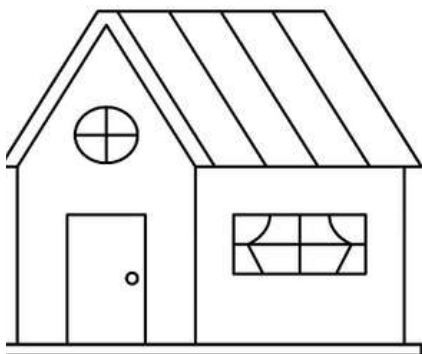

52+ 969 103 0098



@divertilandia.digital



cuadernillosdemate.com ✨

**DIVERTI**  
**LANDIA**

# lectoescritura

Traza

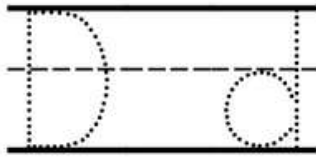

Escribe

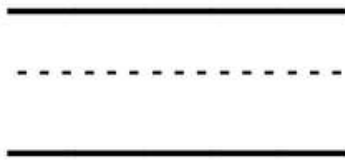

Colorea

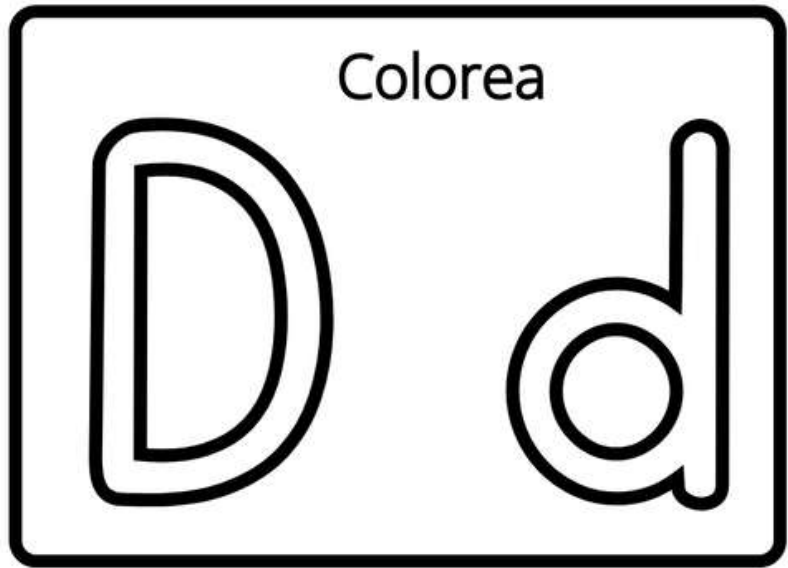

@divertilandia.digital

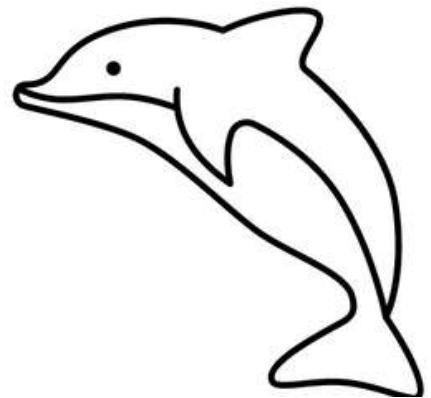
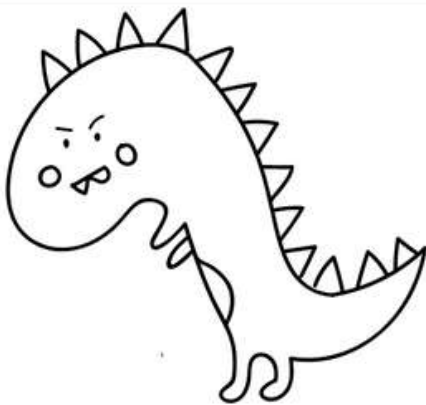
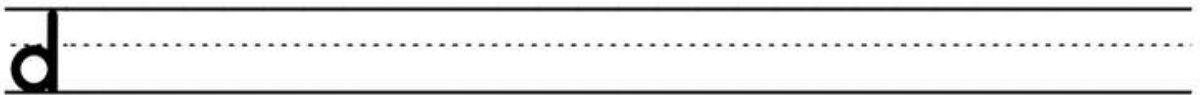
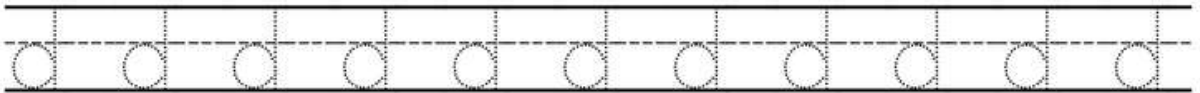
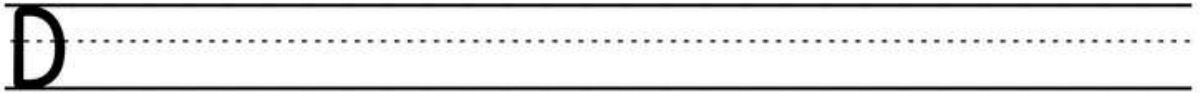
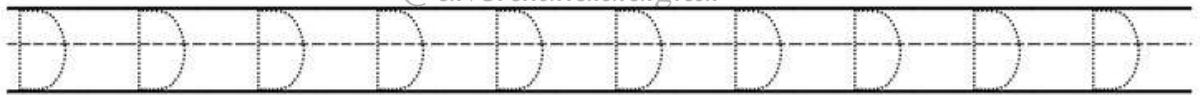

# lectoescritura

Traza



Escribe

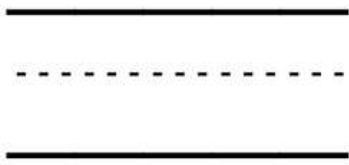

Colorea

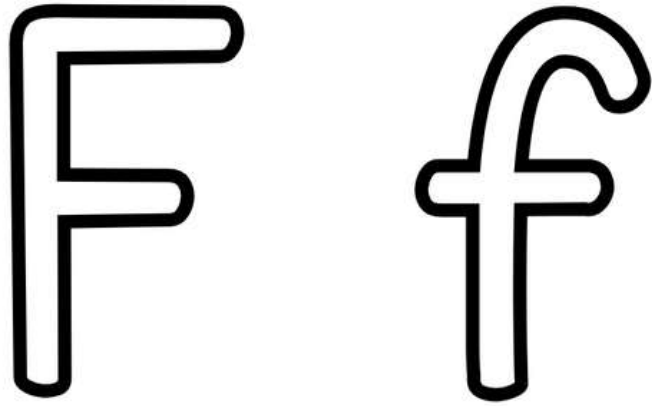

@divertilandia.digital

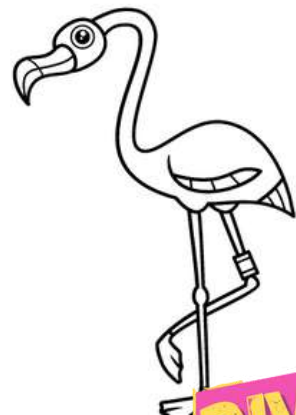
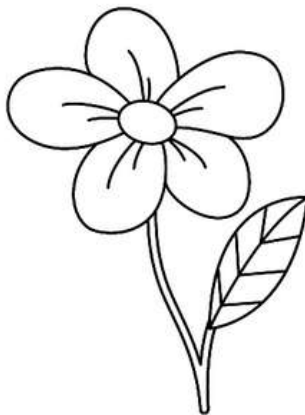
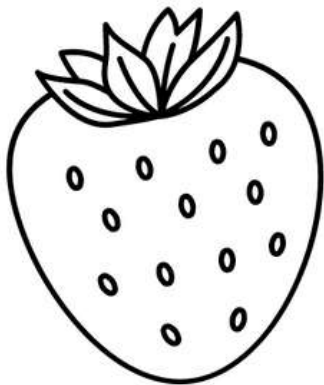
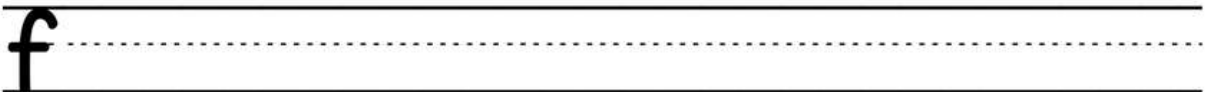
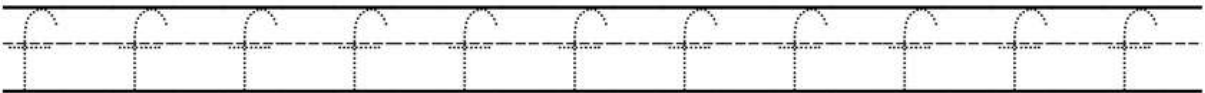
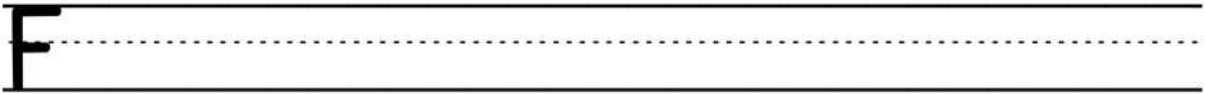

**DIVERTI**  
**LANDIA**

# lectoescritura

Traza

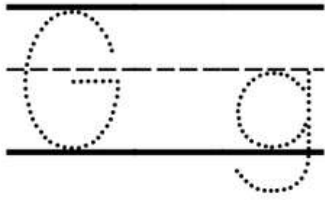

Escribe

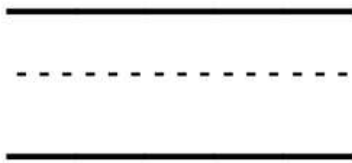

Colorea

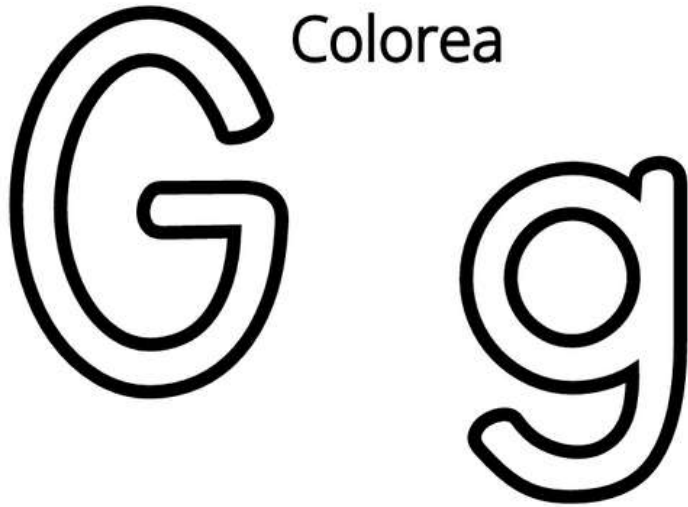

@divertilandia.digital

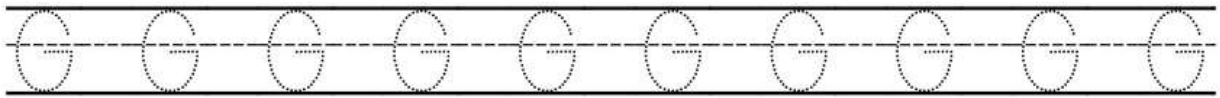

G

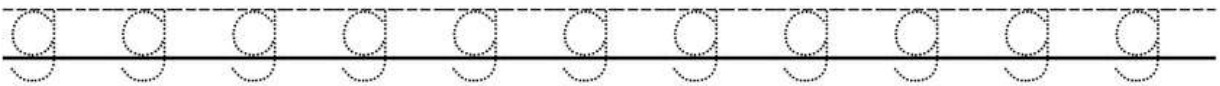

g

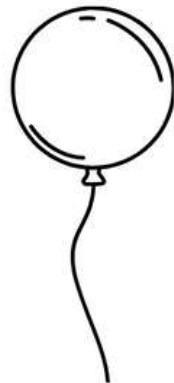
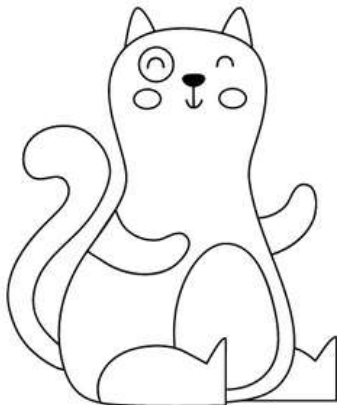



# lectoescritura

Traza

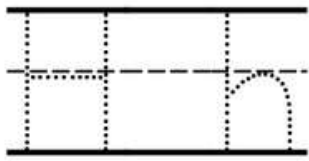

Escribe

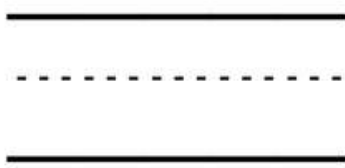

Colorea

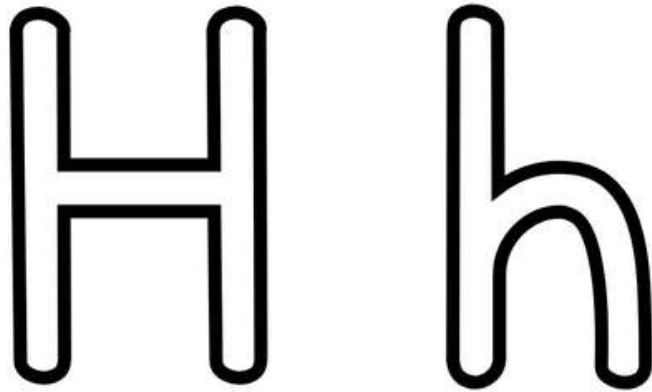

@divertilandia.digital

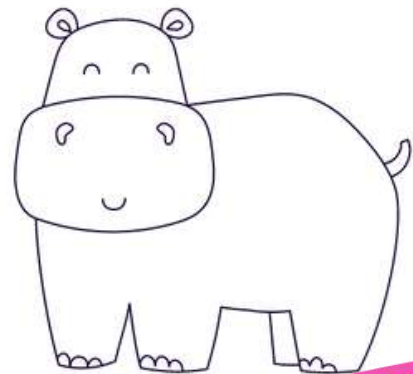
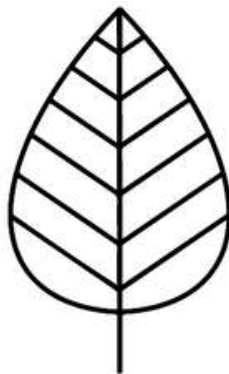
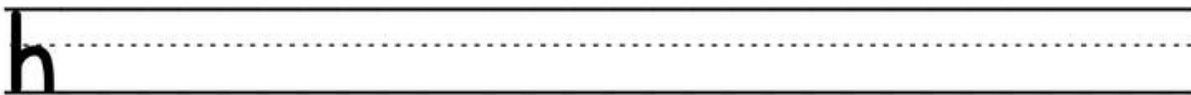
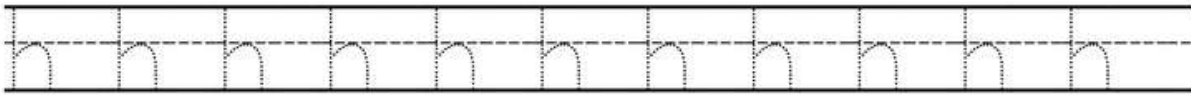
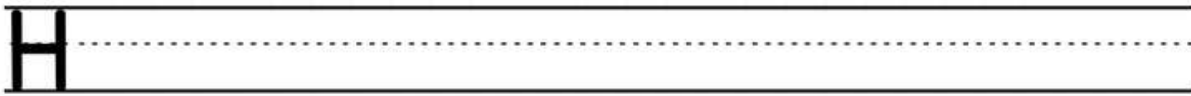
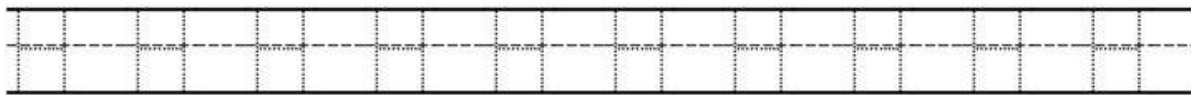

**DIVERTI**  
**LANDIA**

Traza

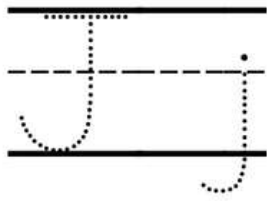

Escribe

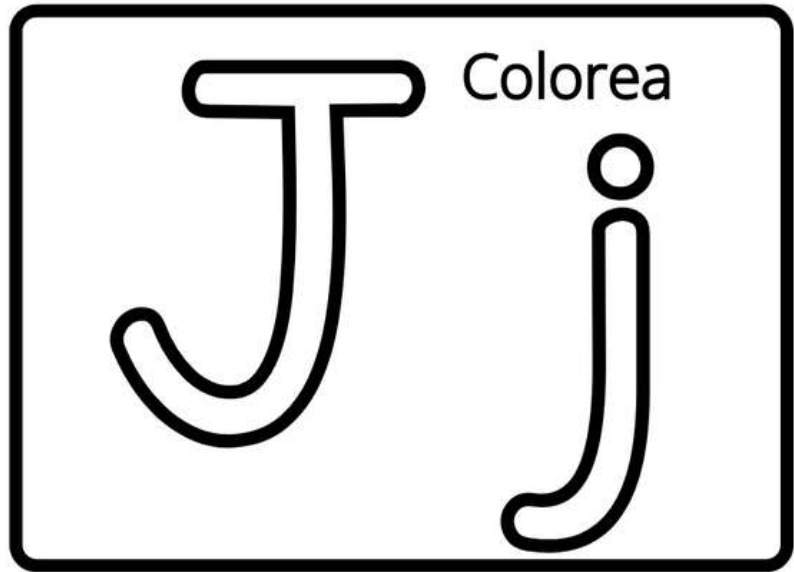
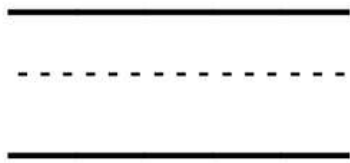

@divertilandia.digital

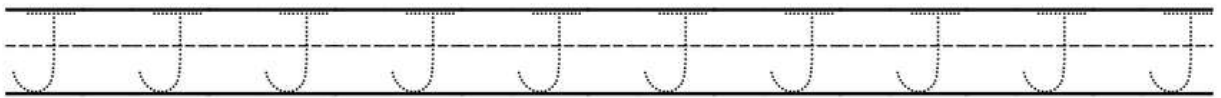

J

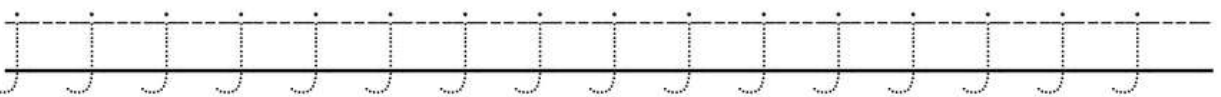

j

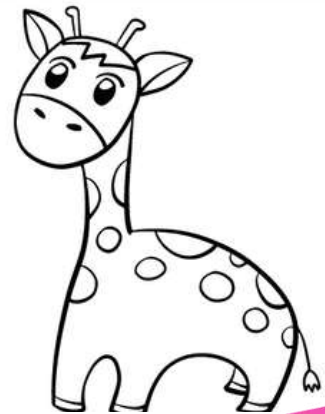

# lectoescritura

Traza

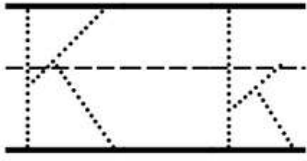

Escribe

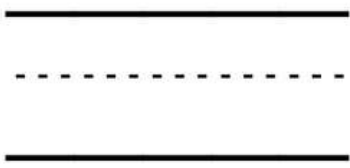

Colorea

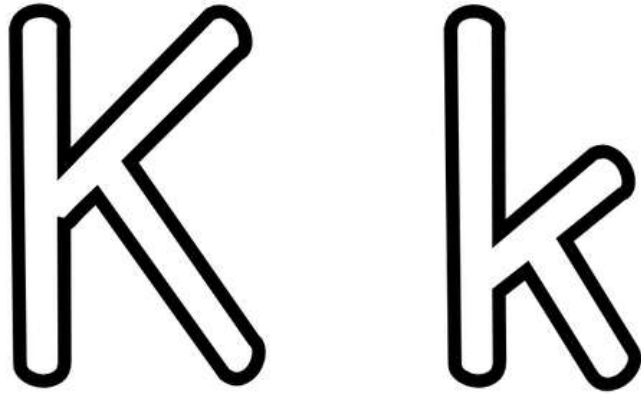

@divertilandia.digital

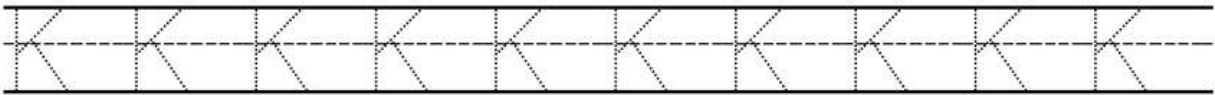

K

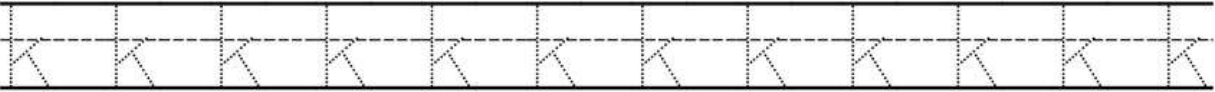

k

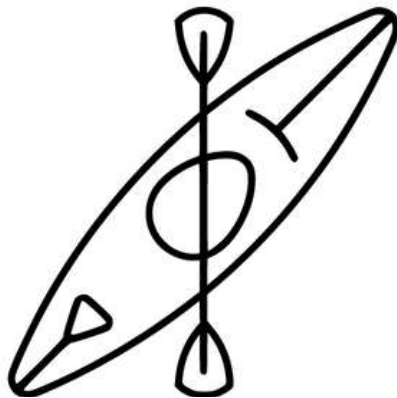
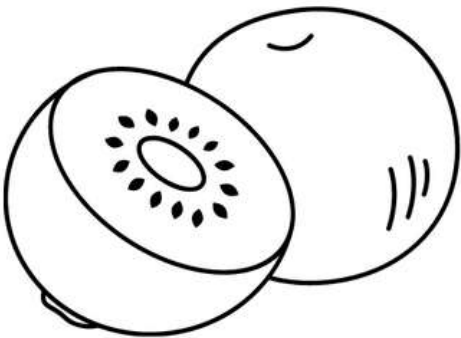

52+ 969 103 0098



@divertilandia.digital



cuadernillosdemate.com



**DIVERTI**  
**LANDIA**

# lectoescritura

Traza

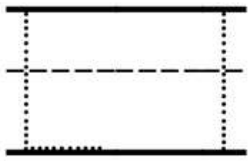

Escribe

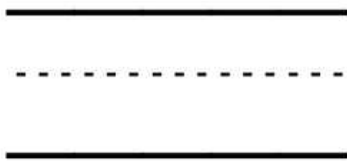

Colorea

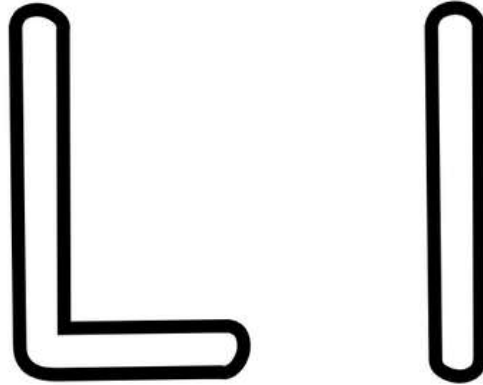

@divertilandia.digital

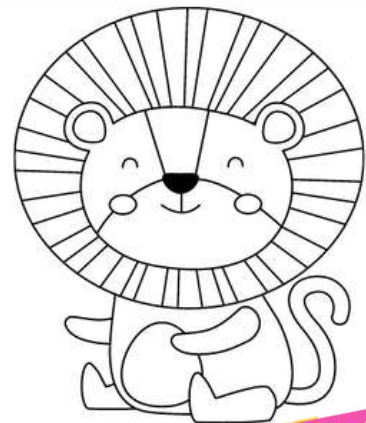
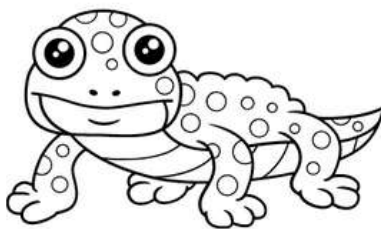
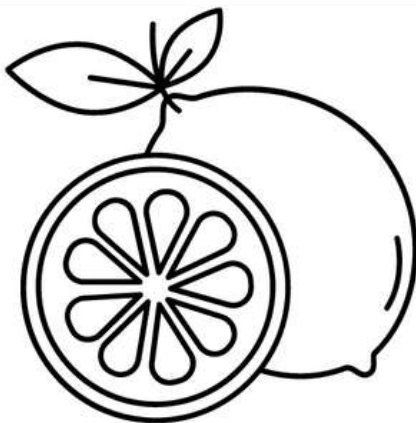
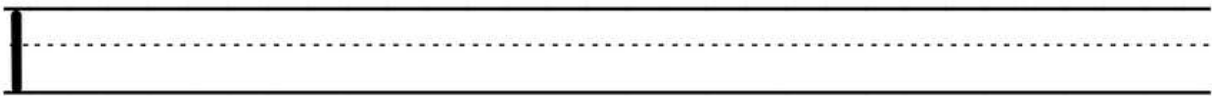
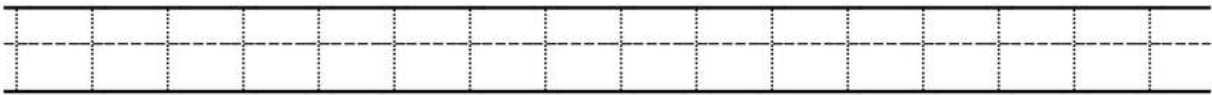
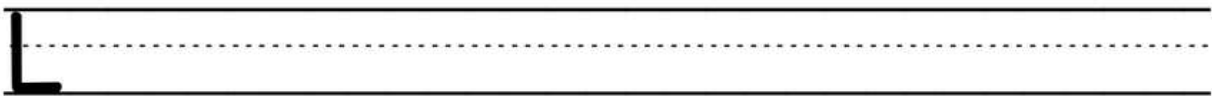

# lectoescritura

Traza

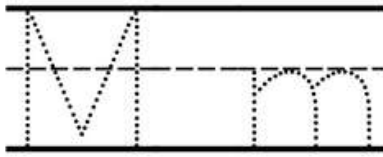

Escribe

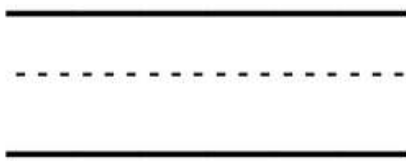

Colorea

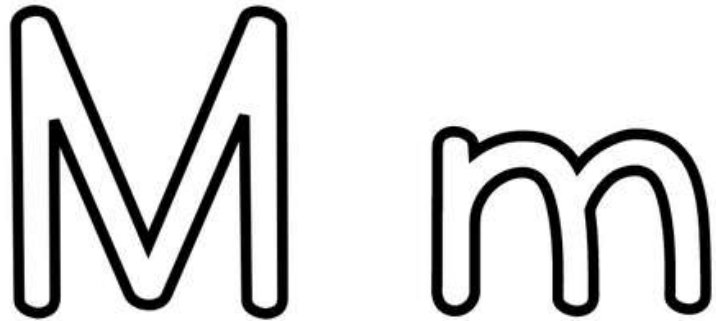

@divertilandia.digital

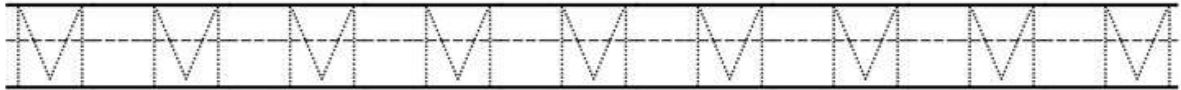

M



m

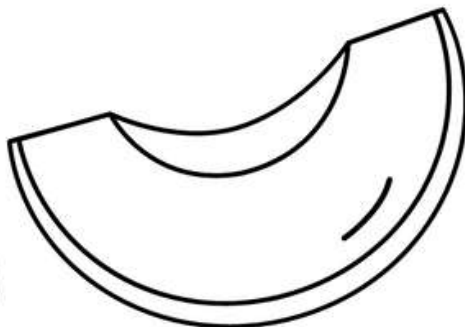
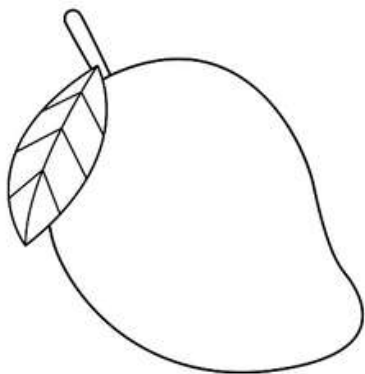

**DIVERTI**  
**LANDIA**

# lectoescritura

Traza

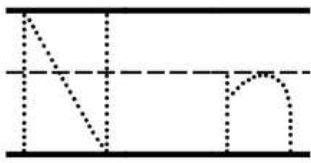

Escribe

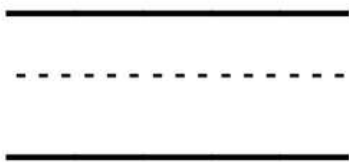

Colorea



@divertilandia.digital

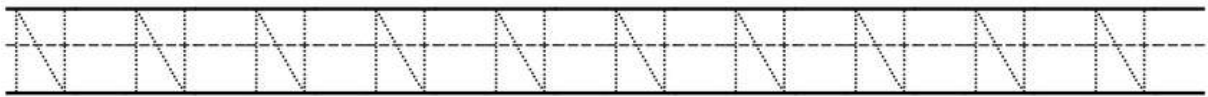

N

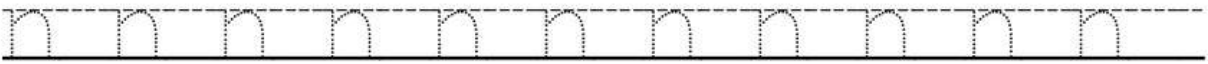

n

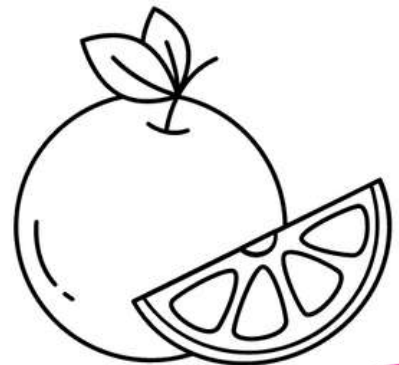
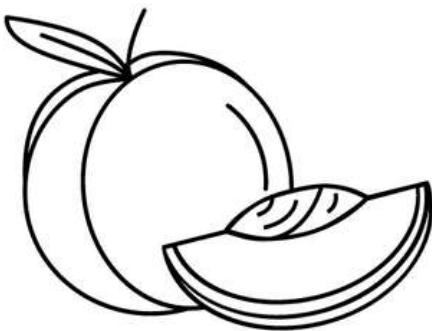

# lectoescritura

Traza

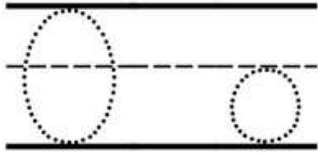

Escribe

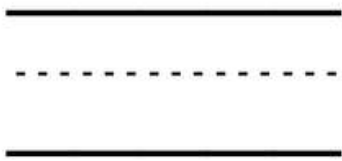

Colorea

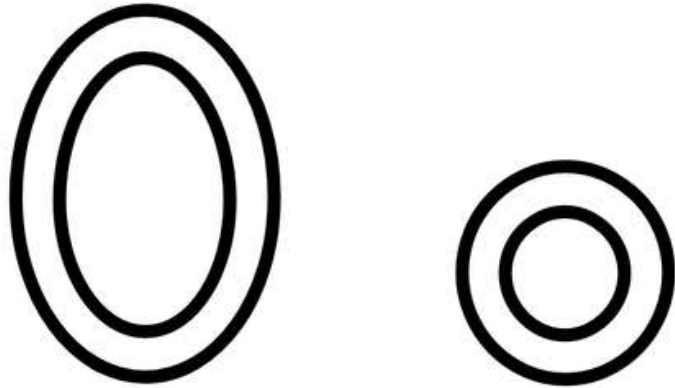

@divertilandia.digital

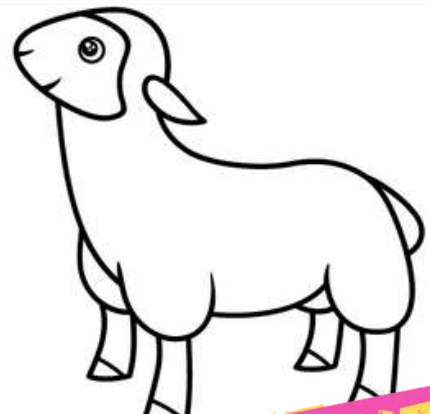
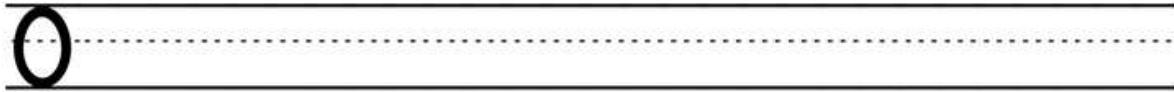
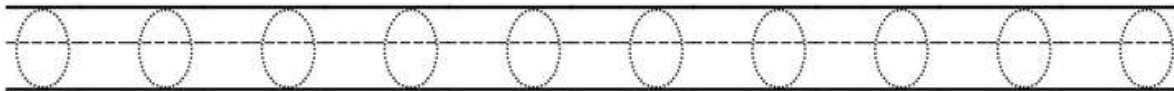

**DIVERTI**  
**LANDIA**

# lectoescritura

Traza

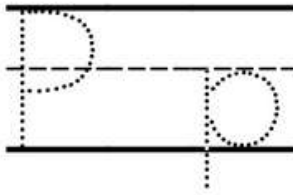

Escribe

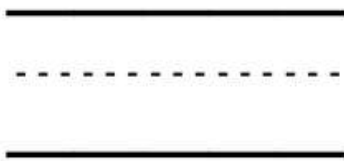

Colorea

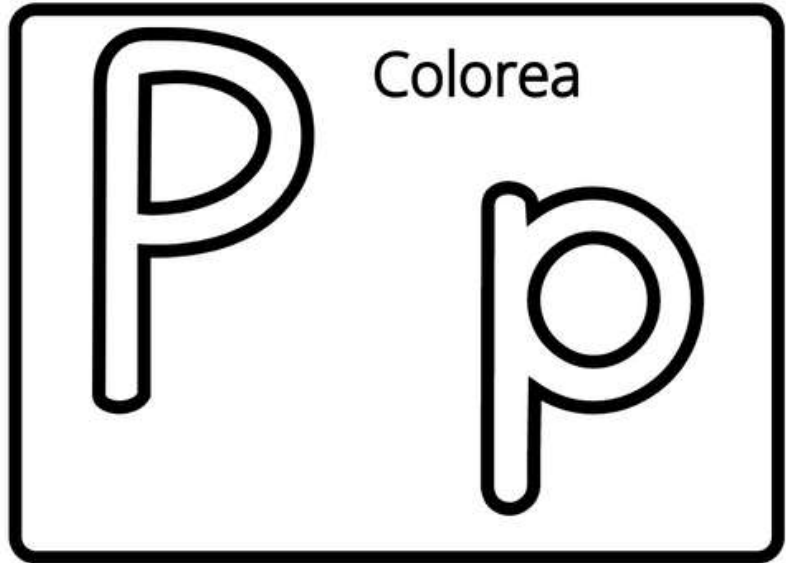

@divertilandia.digital

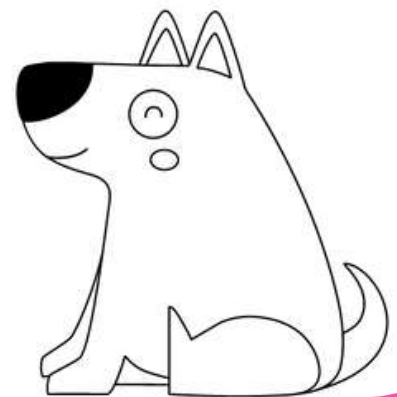
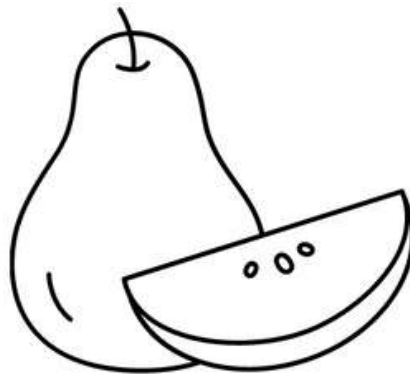
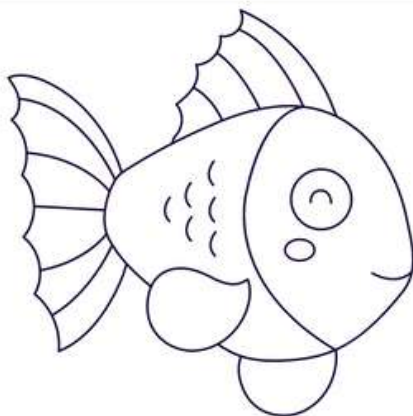
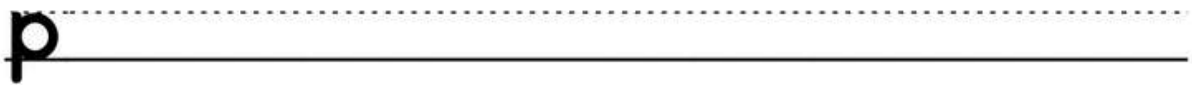
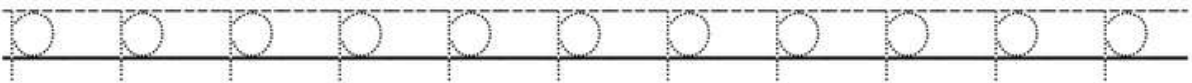
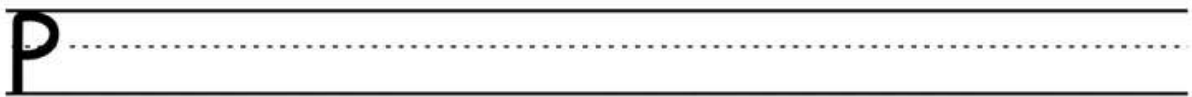
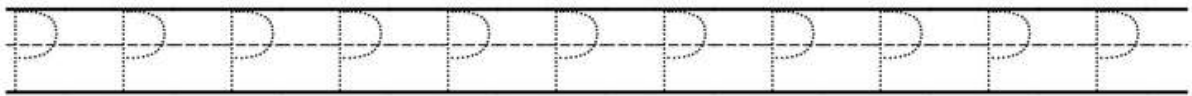



# lectoescritura

Traza

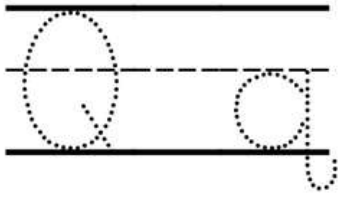

Escribe

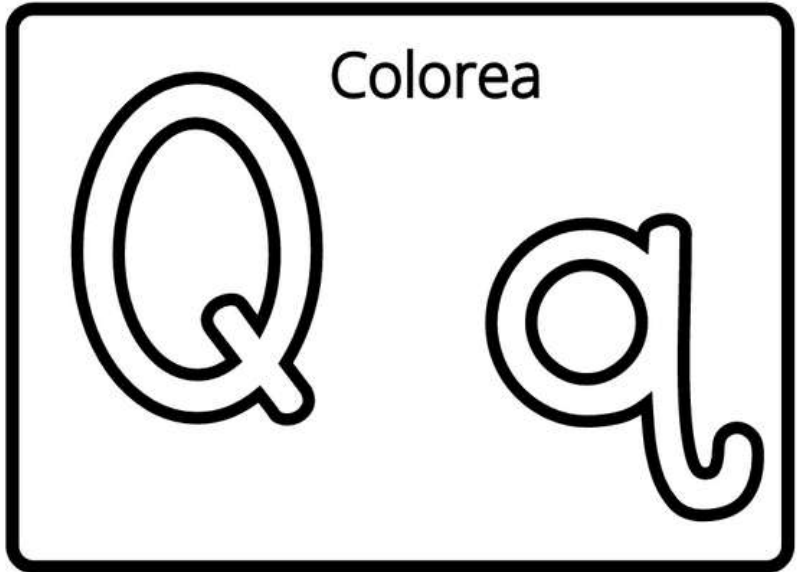
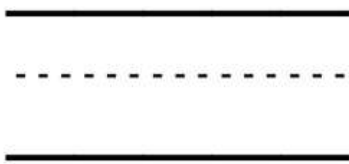

@divertilandia.digital

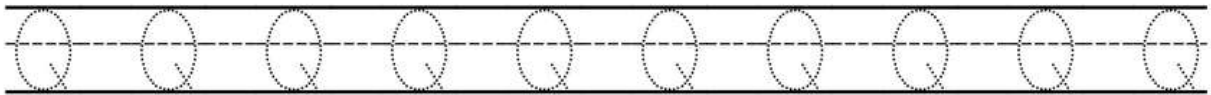

Q

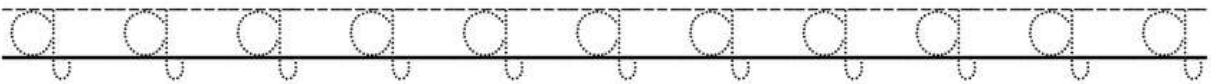

q

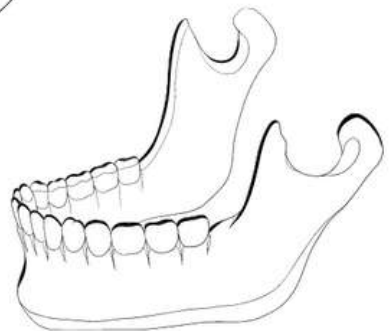
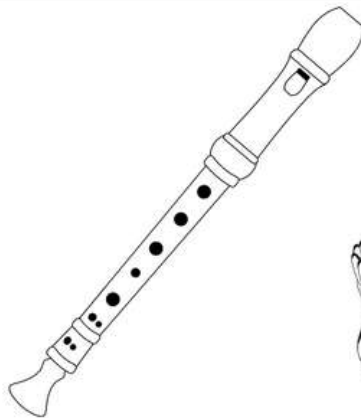
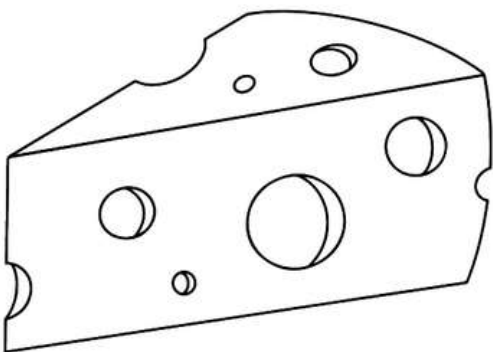

# lectoescritura

Traza

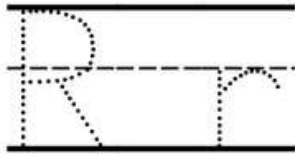

Escribe

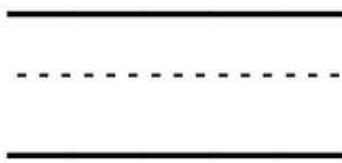

Colorea

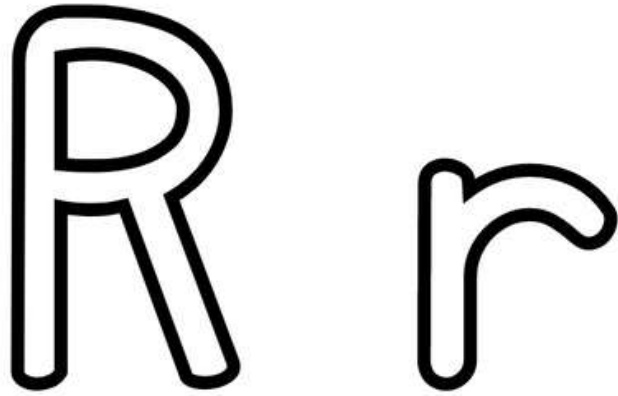

@divertilandia.digital



R

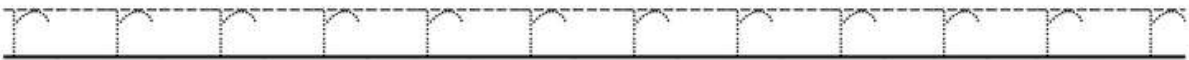

r

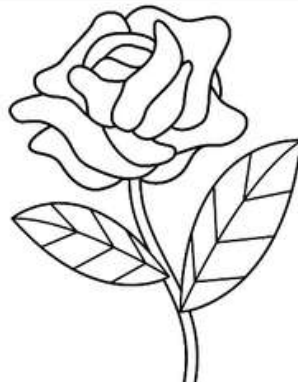
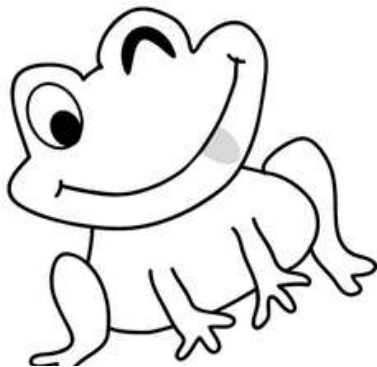

**DIVERTI**  
**LANDIA**

# lectoescritura

Traza

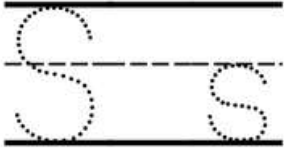

Escribe

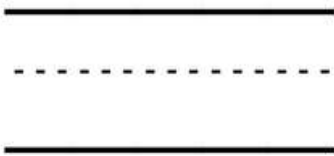

Colorea

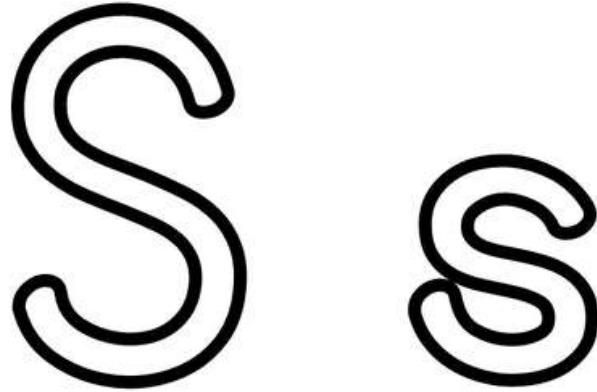

@divertilandia.digital

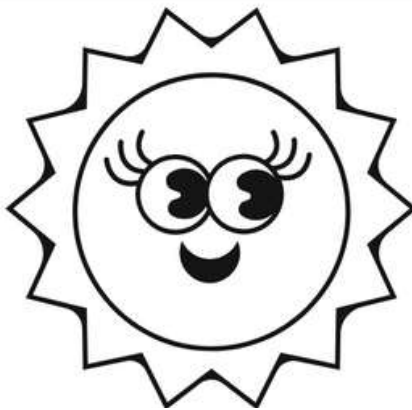
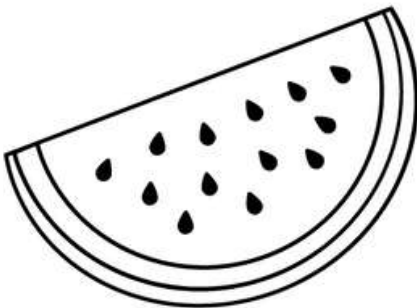
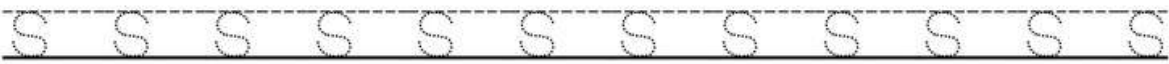
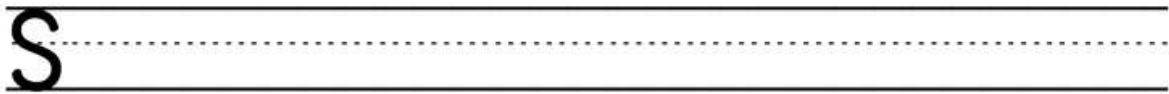
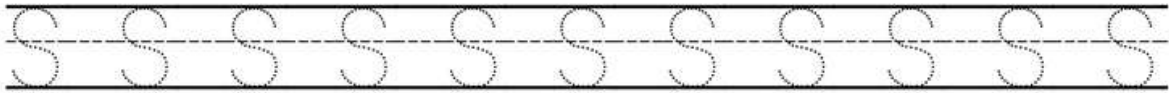

# lectoescritura

Traza

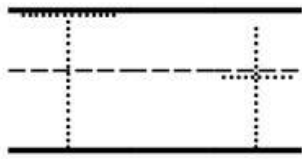

Escribe

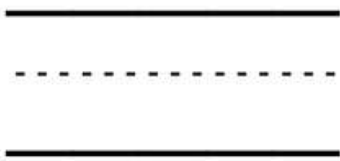

Colorea

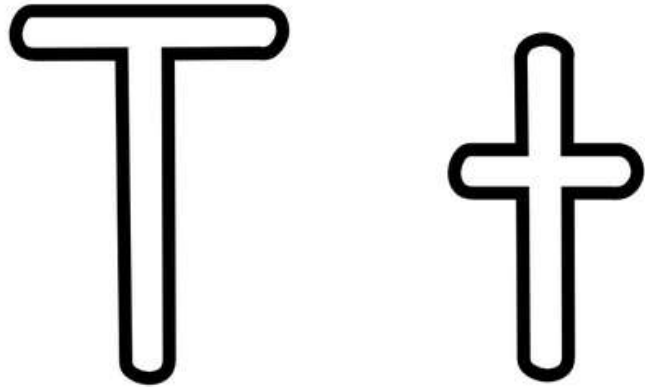

@divertilandia.digital

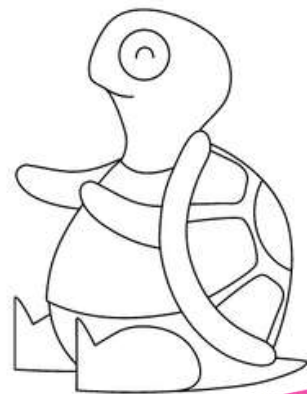
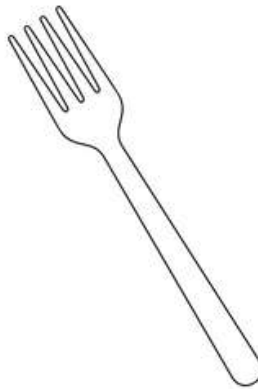
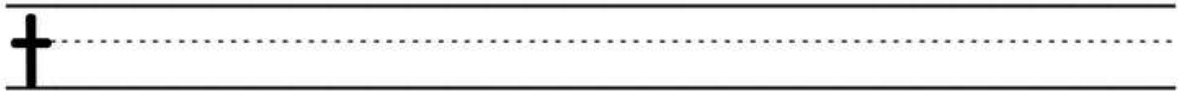
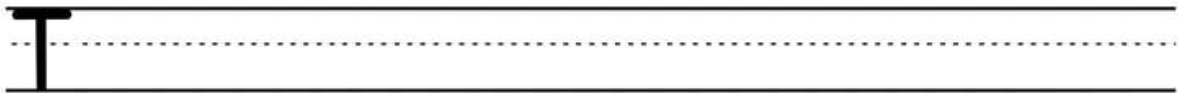

**DIVERTI**  
**LANDIA**

# lectoescritura

Traza

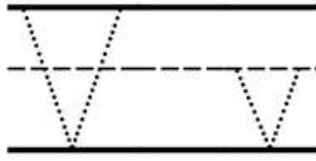

Escribe

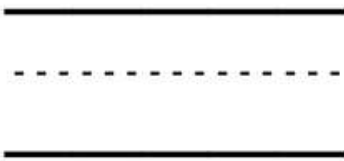

Colorea



@divertilandia.digital

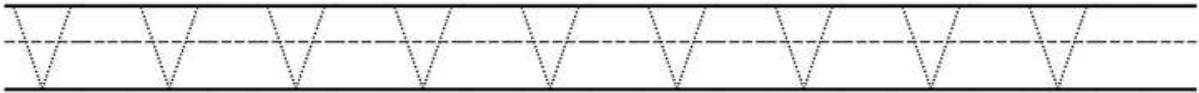

V



v

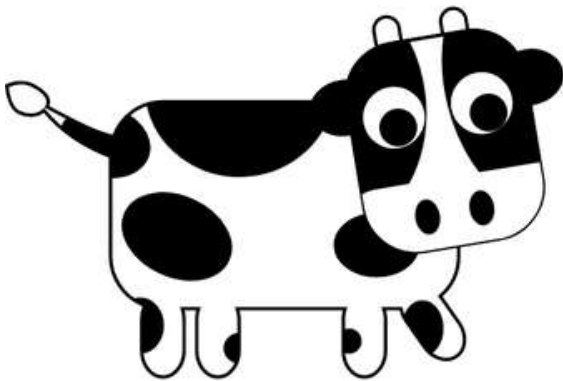

52+ 969 103 0098



@divertilandia.digital



cuadernillosdemate.com ✨

**DIVERTI**  
**LANDIA**

# lectoescritura

Traza

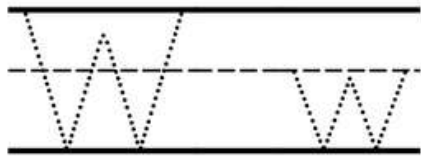

Escribe

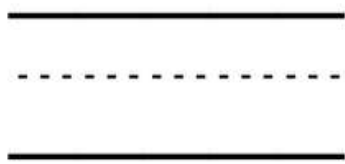

Colorea



@divertilandia.digital

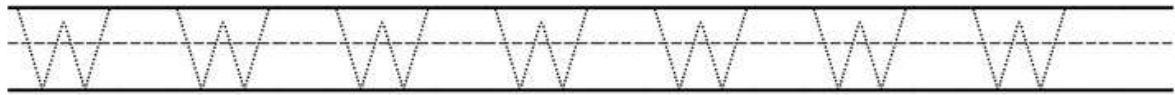

W



w

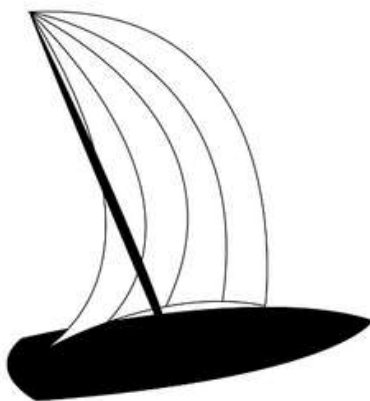

# lectoescritura

Traza

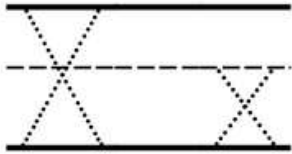

Escribe

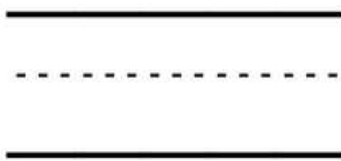

Colorea

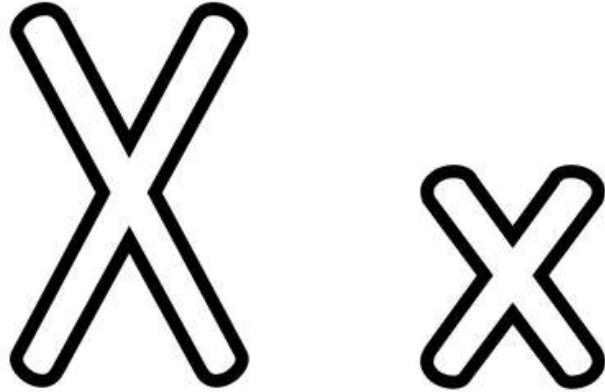

@divertilandia.digital

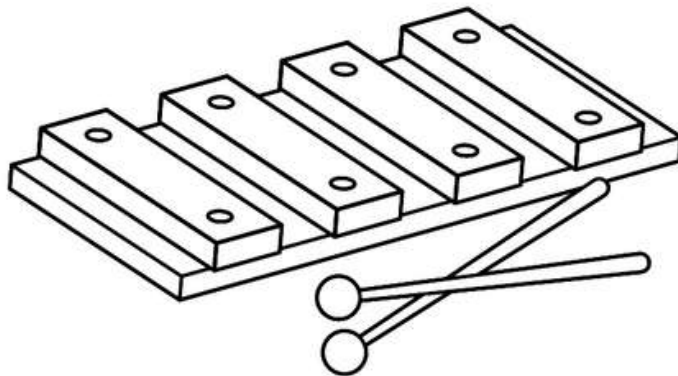
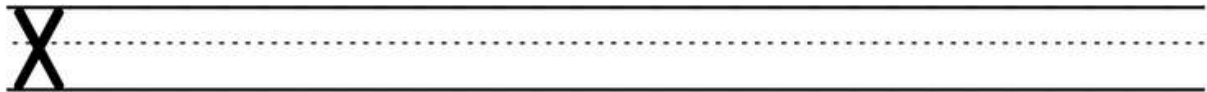
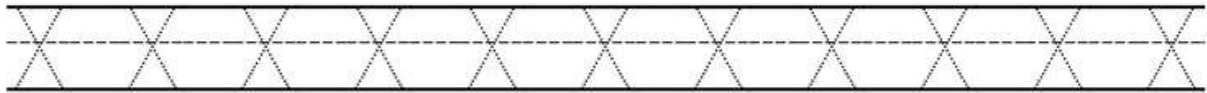

# lectoescritura

Traza

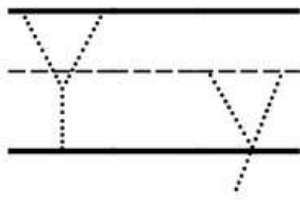

Escribe

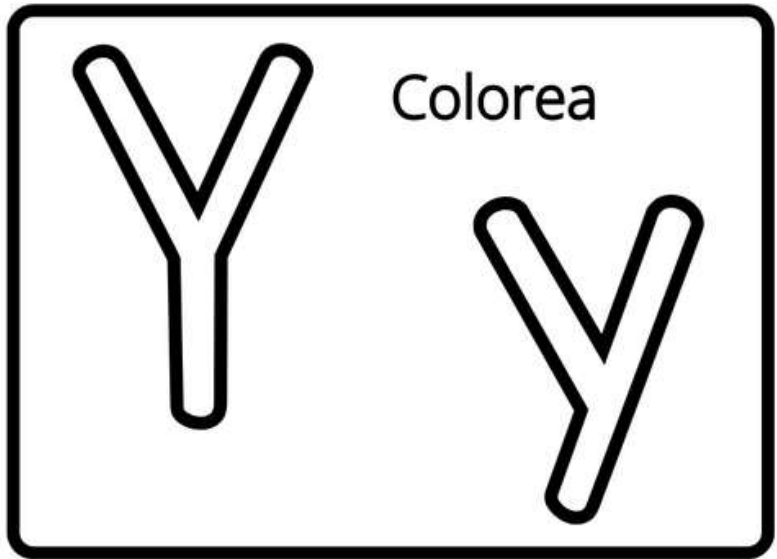
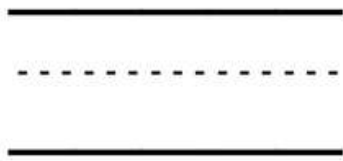

@divertilandia.digital

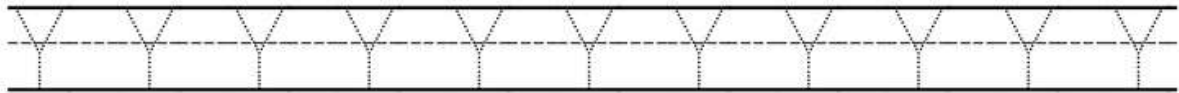

Y

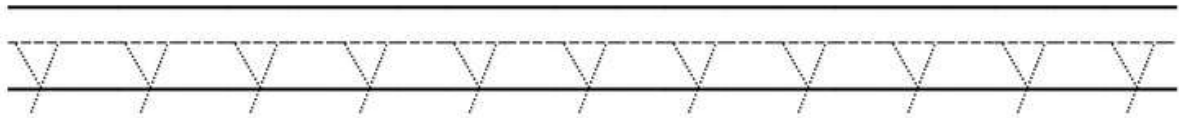

y

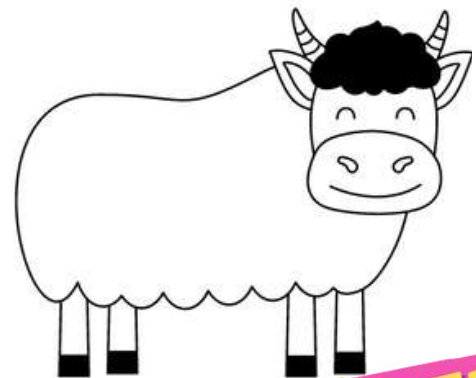
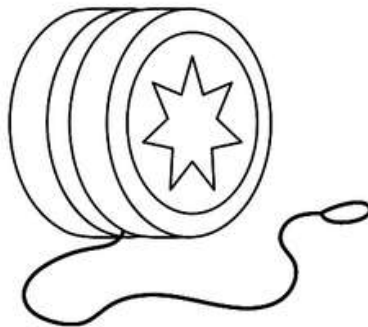
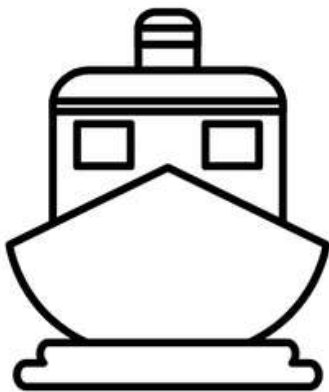

**DIVERTI**  
**LANDIA**



# lectoescritura

Traza

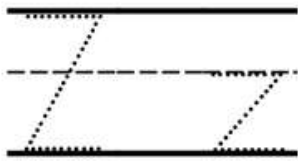

Escribe

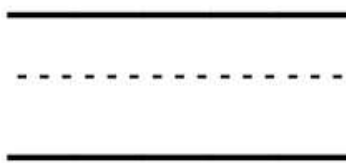

Colorea

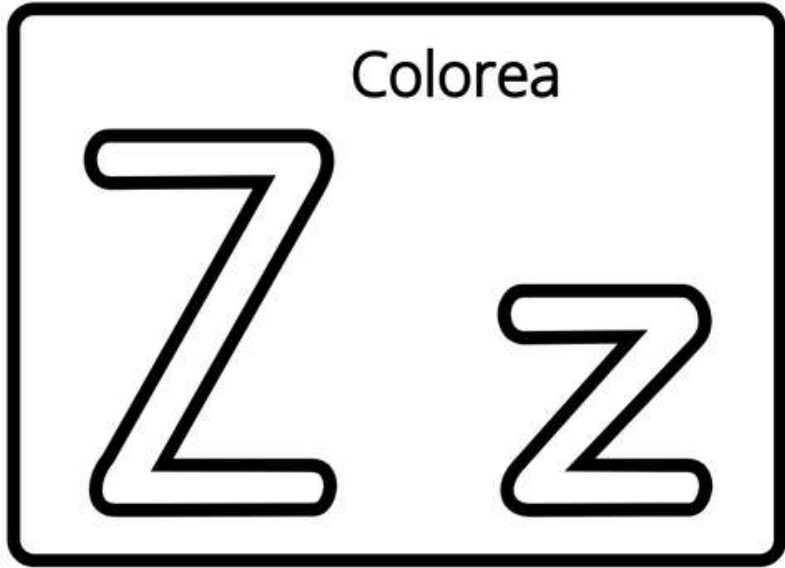

@divertilandia.digital

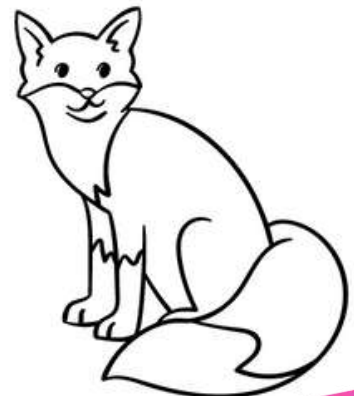
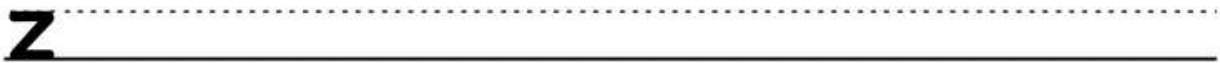
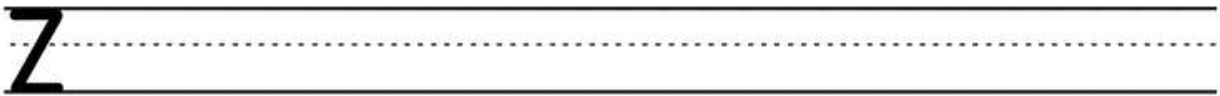
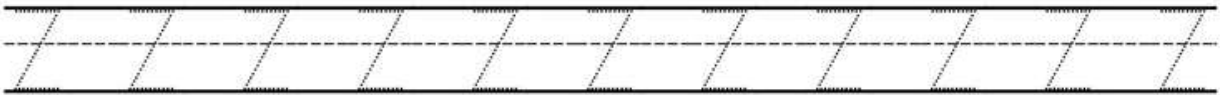

lectoescritura 

Bb

@divertilandia.digital

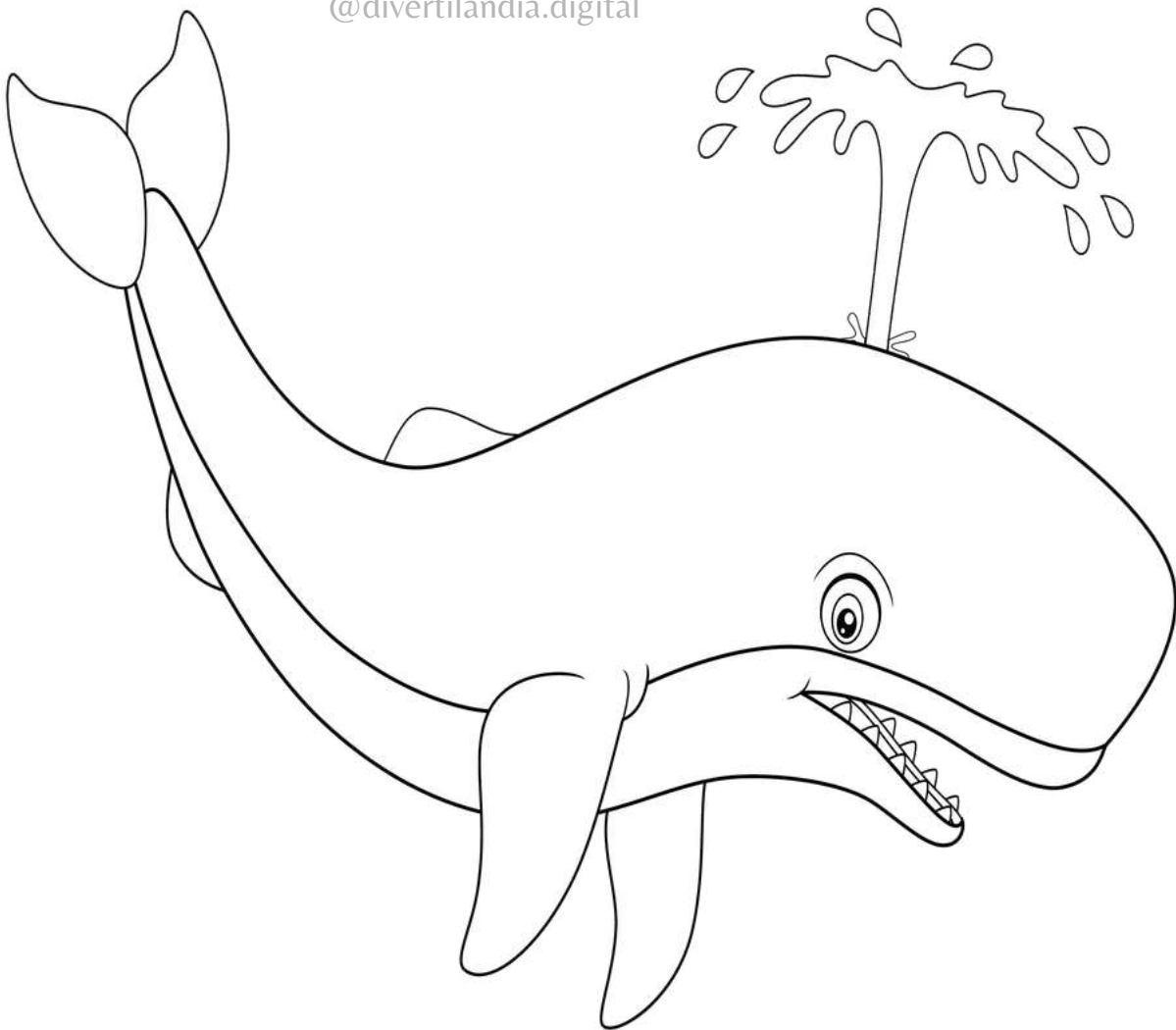

Ballena

lectoescritura 

Cc

@divertilandia.digital

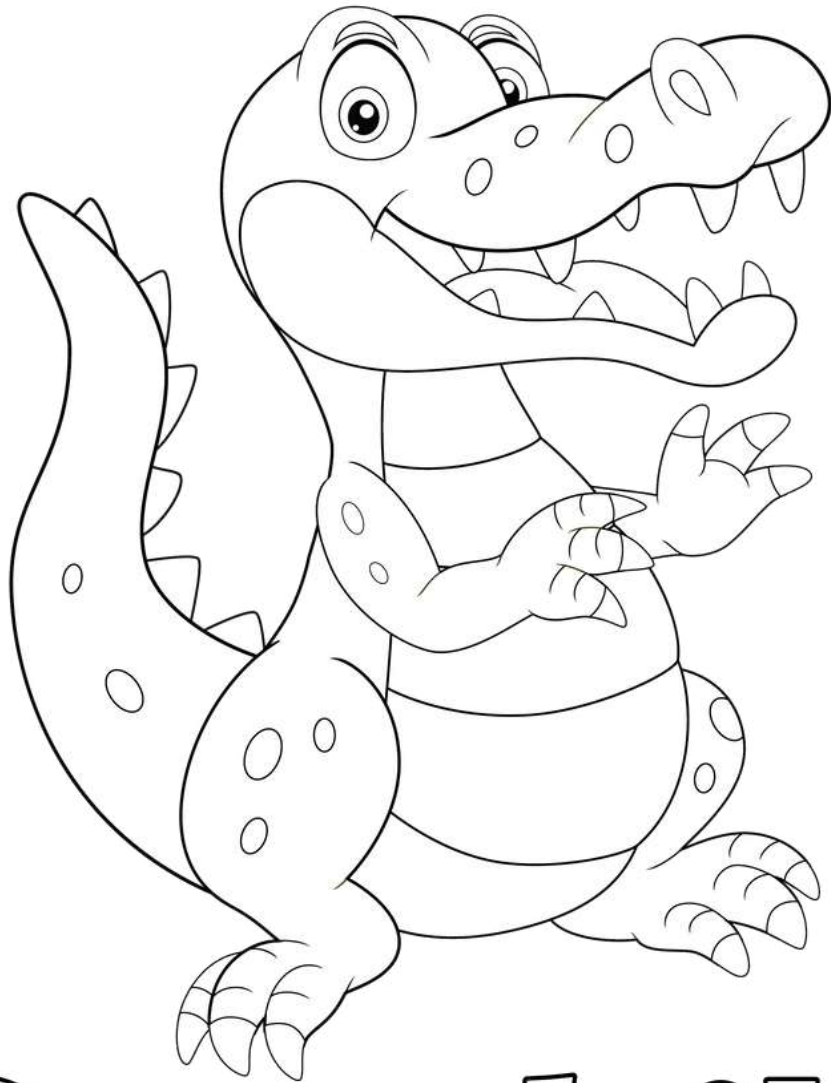

Cocodrilo

lectoescritura 

Dd

@divertilandia.digital

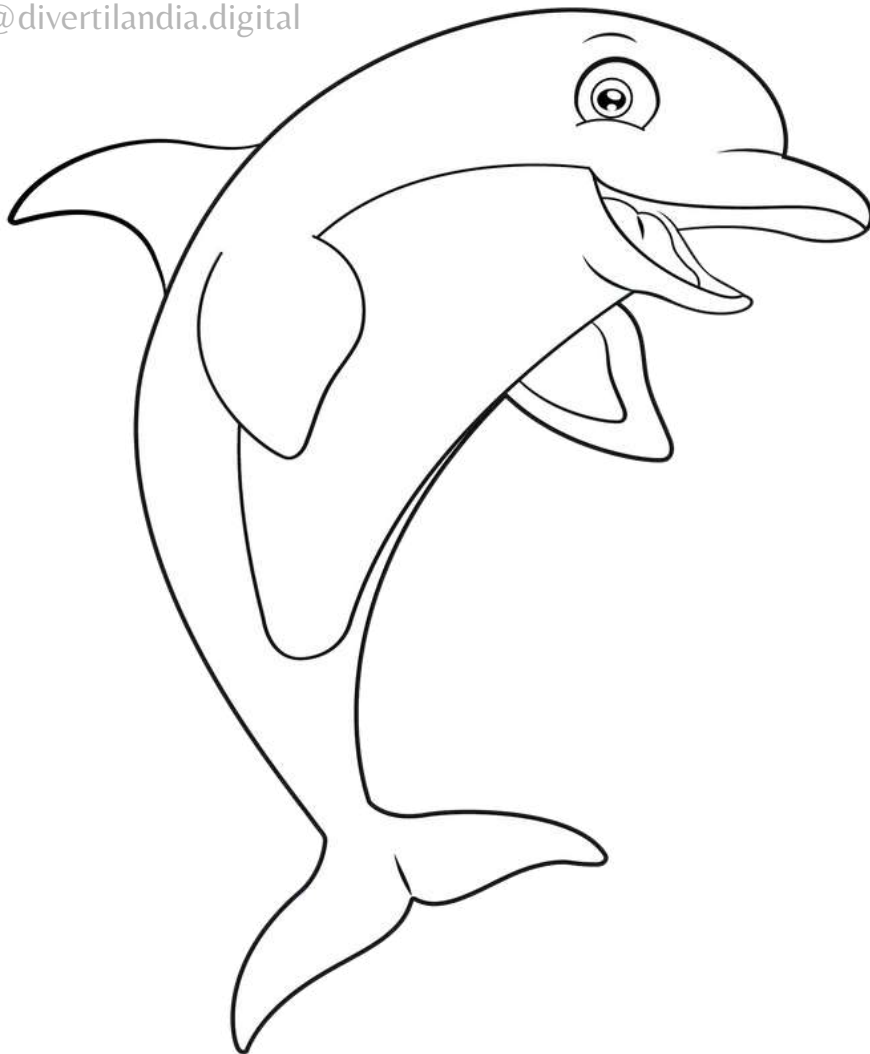

Delfín



52+ 969 103 0098



@divertilandia.digital



cuadernillosdemate.com ✨

**DIVERTI**  
**LANDIA**

lectoescritura 

Ff

@divertilandia.digital

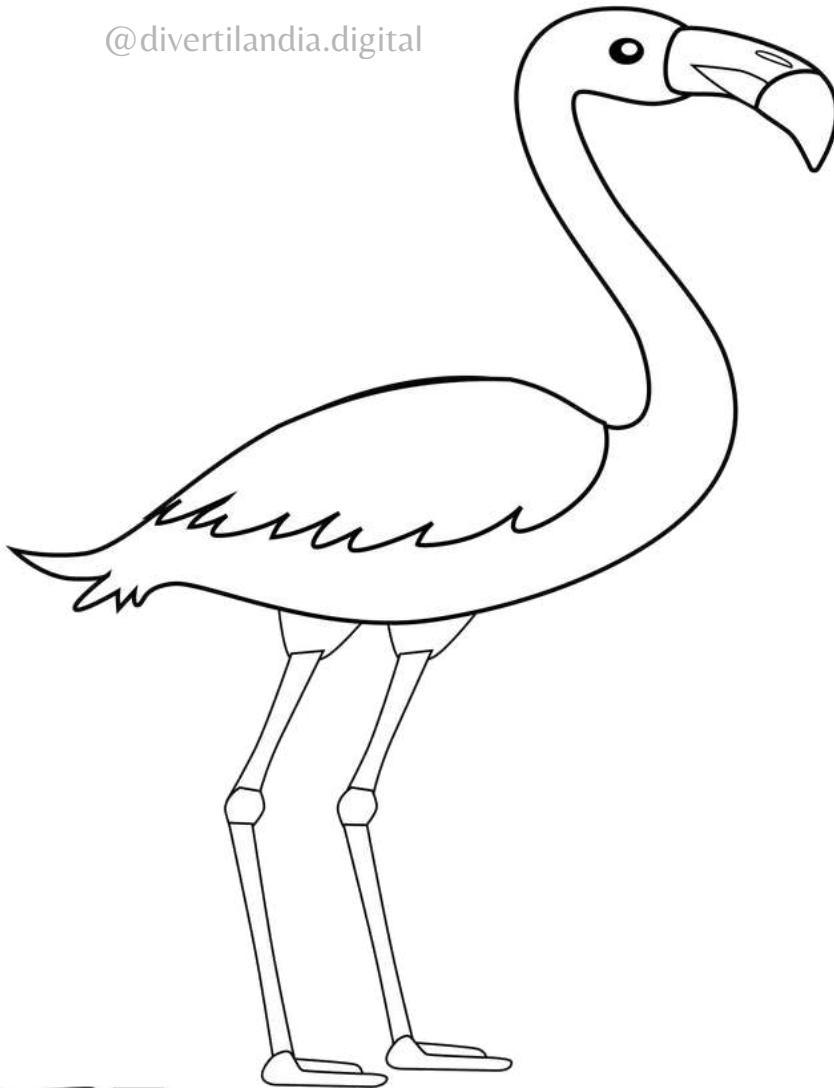

Flamenco

Gg

@divertilandia.digital

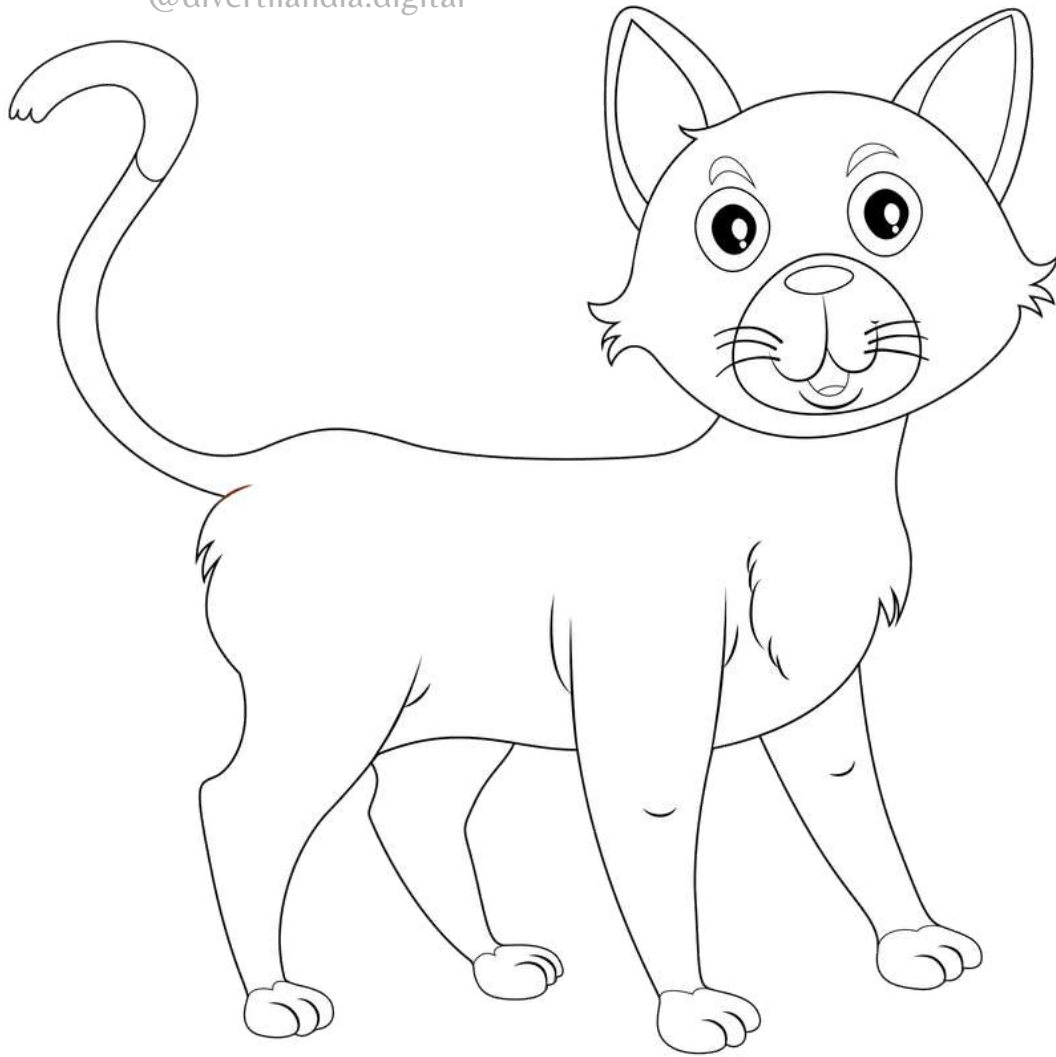

Gato

lectoescritura 

Hh

@divertilandia.digital

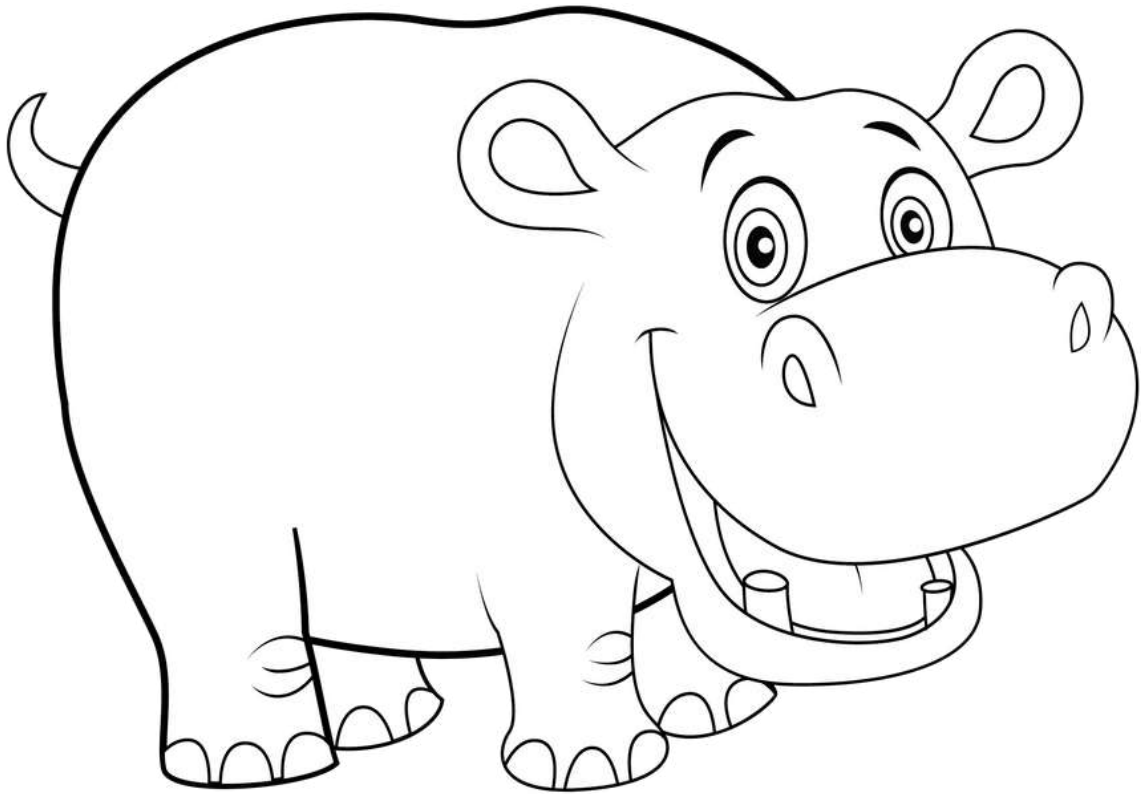

Hipopótamo

lectoescritura 

Jj

@divertilandia.digital

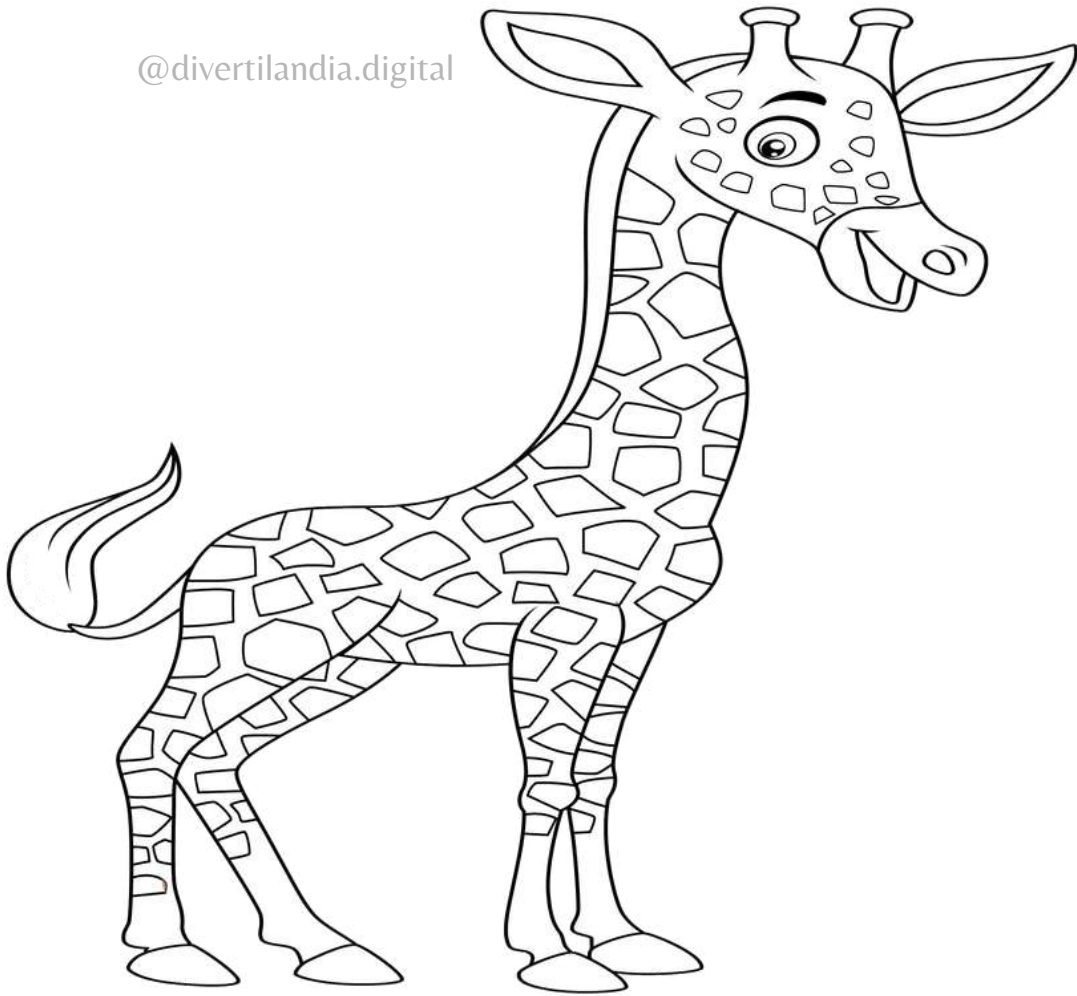

Jirafa



lectoescritura 

KK

@divertilandia.digital



Koala

LI

@divertilandia.digital



León



Mm

@divertilandia.digital

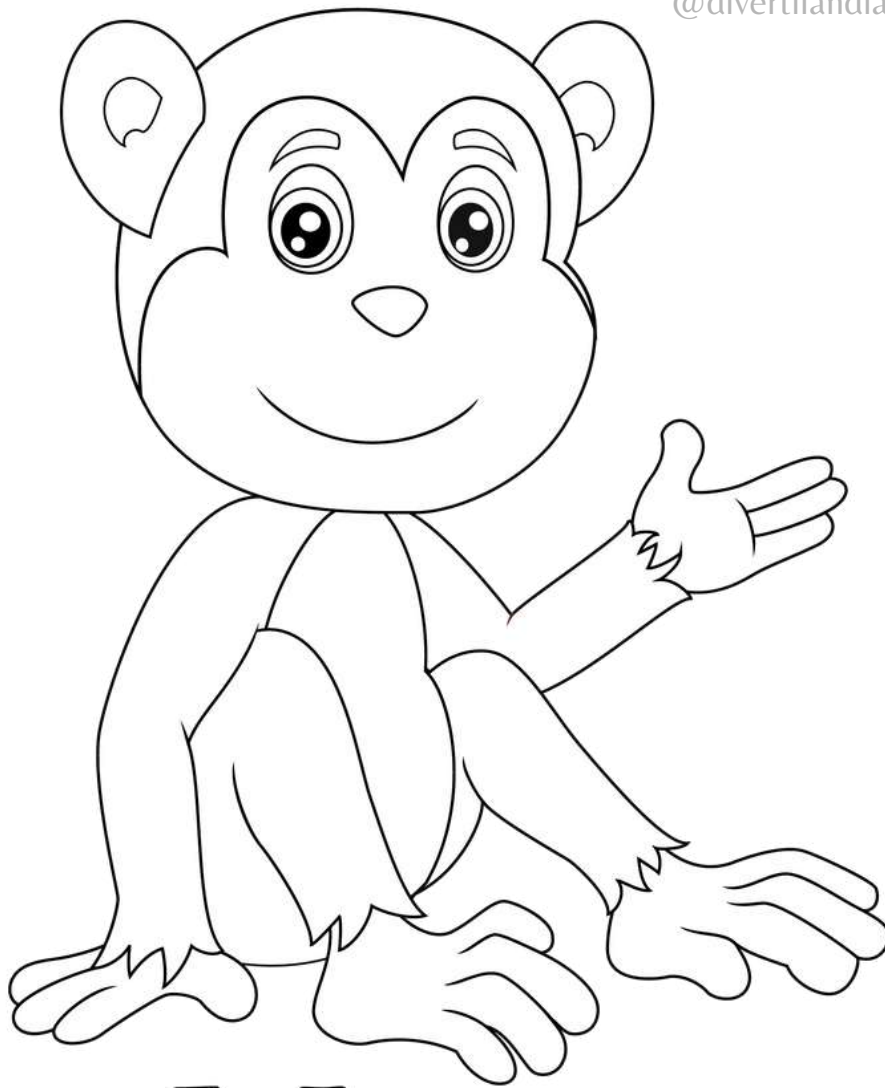

Mono

lectoescritura 

Nn

@divertilandia.digital



Nandou



52+ 969 103 0098



@divertilandia.digital



cuadernillosdemate.com 

**DIVERTI**  
**LANDIA**

# lectoescritura

# N ñ

@divertilandia.digital

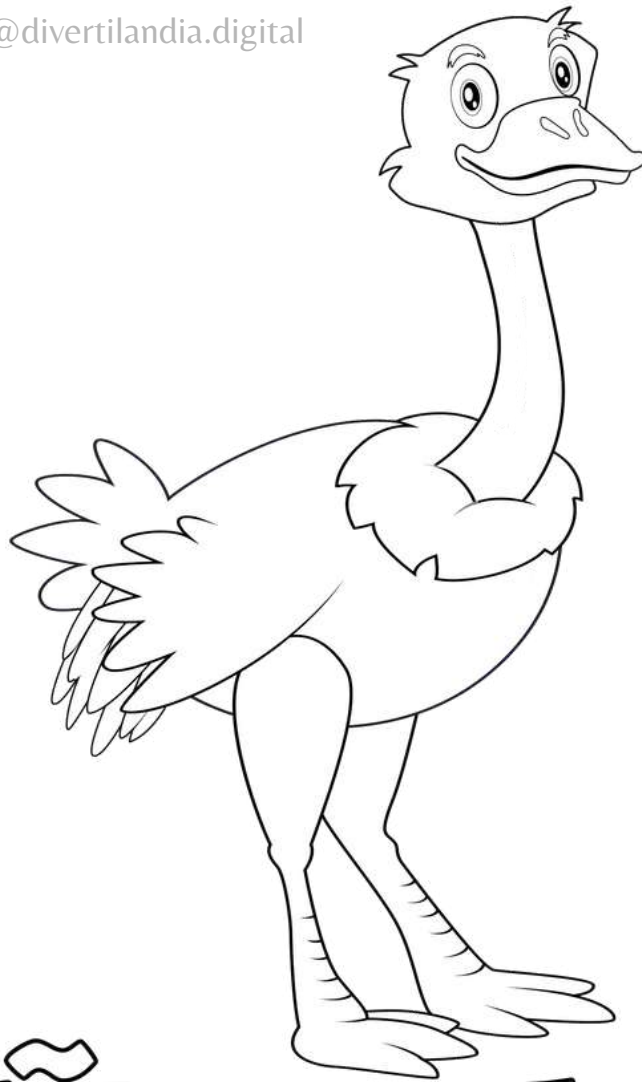

# Nandú

lectoescritura 

Pp

@divertilandia.digital

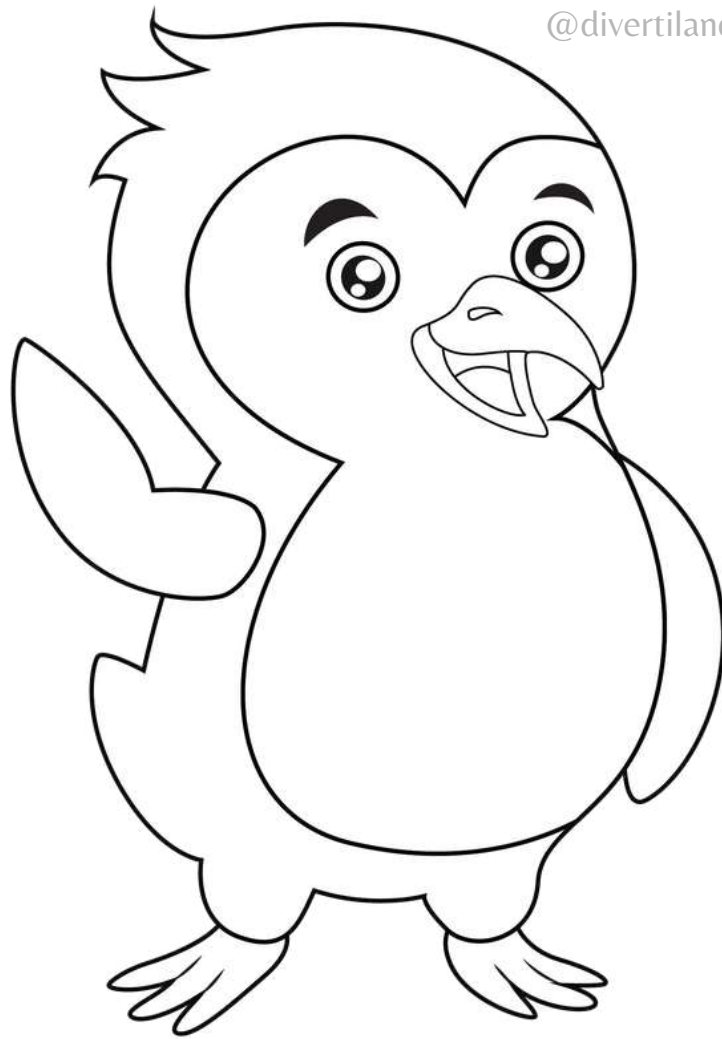

Pingüino



52+ 969 103 0098



@divertilandia.digital



cuadernillosdemate.com 

**DIVERTI**  
**LANDIA**



Q q



@divertilandia.digital

Queso

lectoescritura 

Rr

@divertilandia.digital



Rana



Ss

@divertilandia.digital



Serpiente

lectoescritura 

Tt

@divertilandia.digital

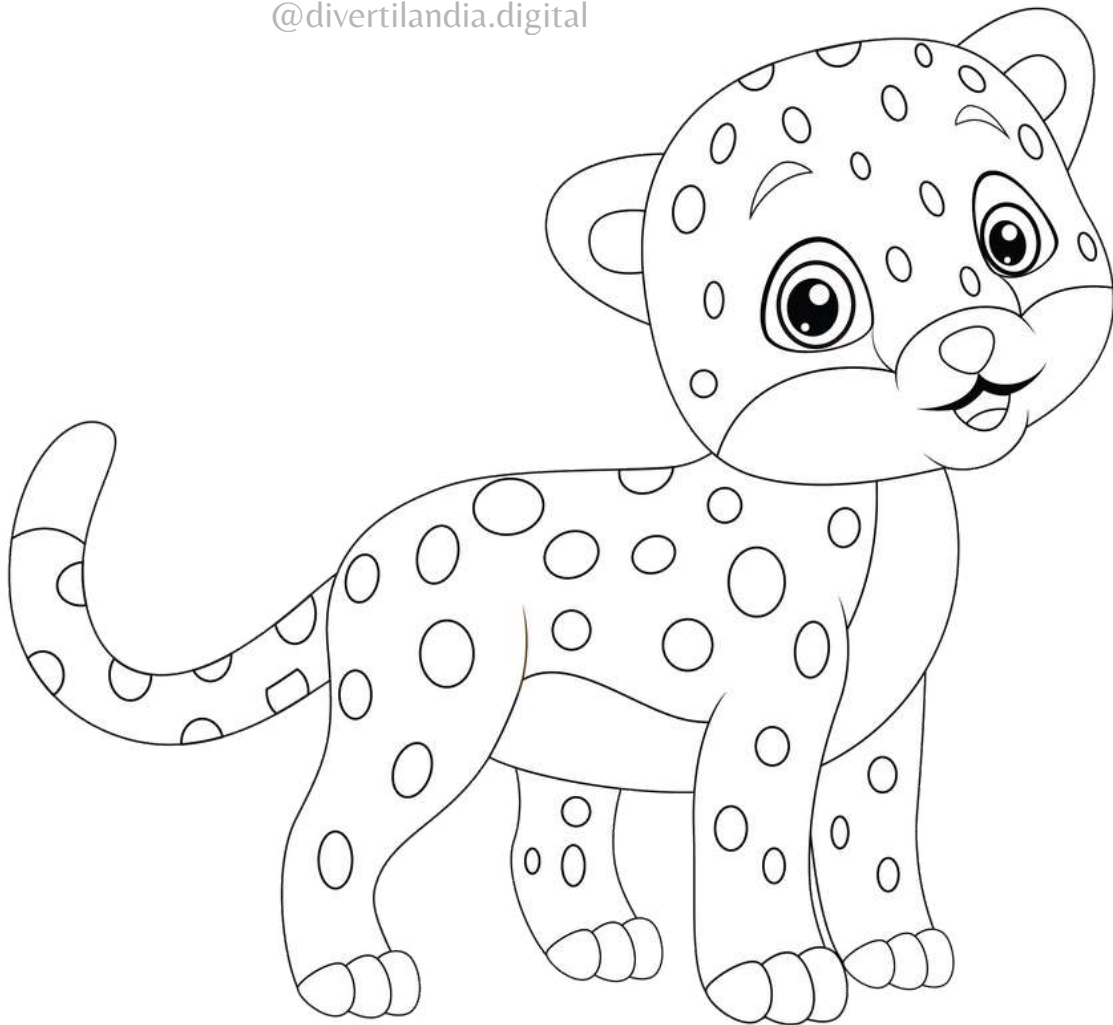

Tigre

# lectoescritura

V v

@divertilandia.digital

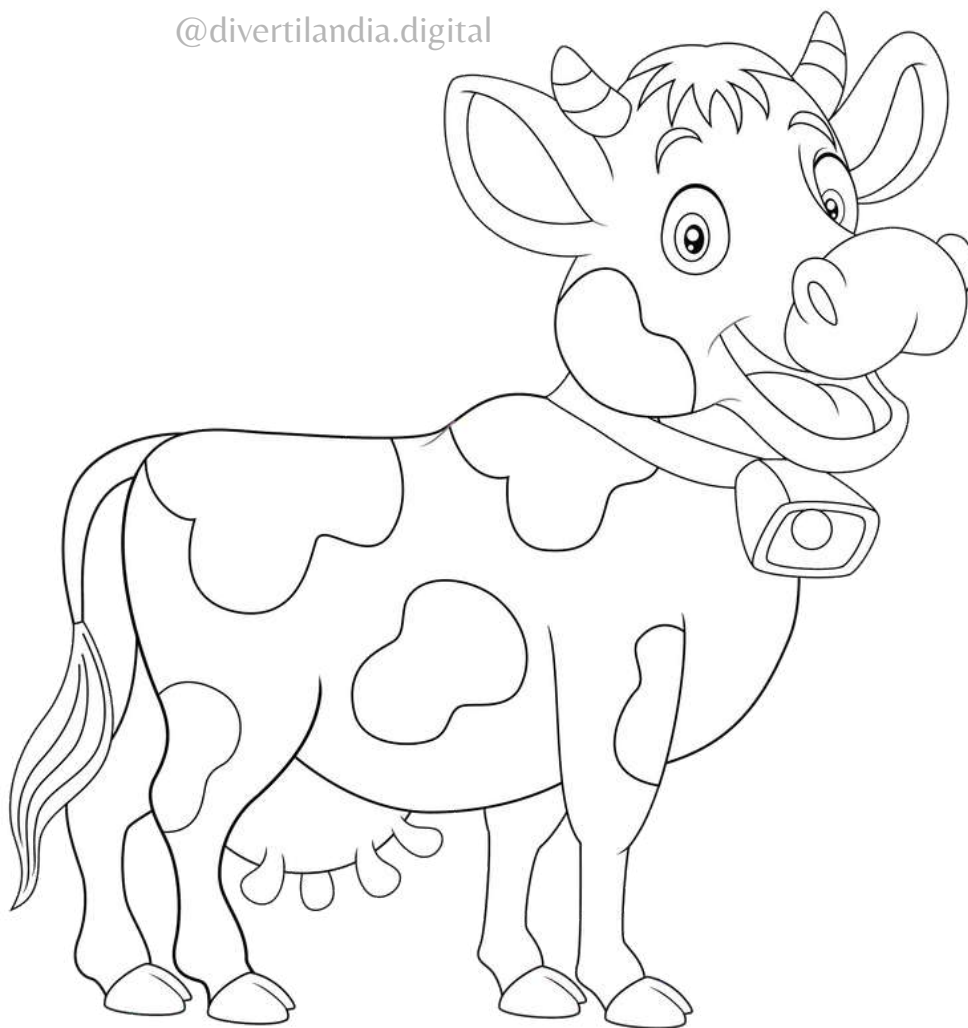

Vaca



52+ 969 103 0098



@divertilandia.digital



cuadernillosdemate.com ✨

**DIVERTI**  
**LANDIA**

# lectoescritura

W w

@divertilandia.digital

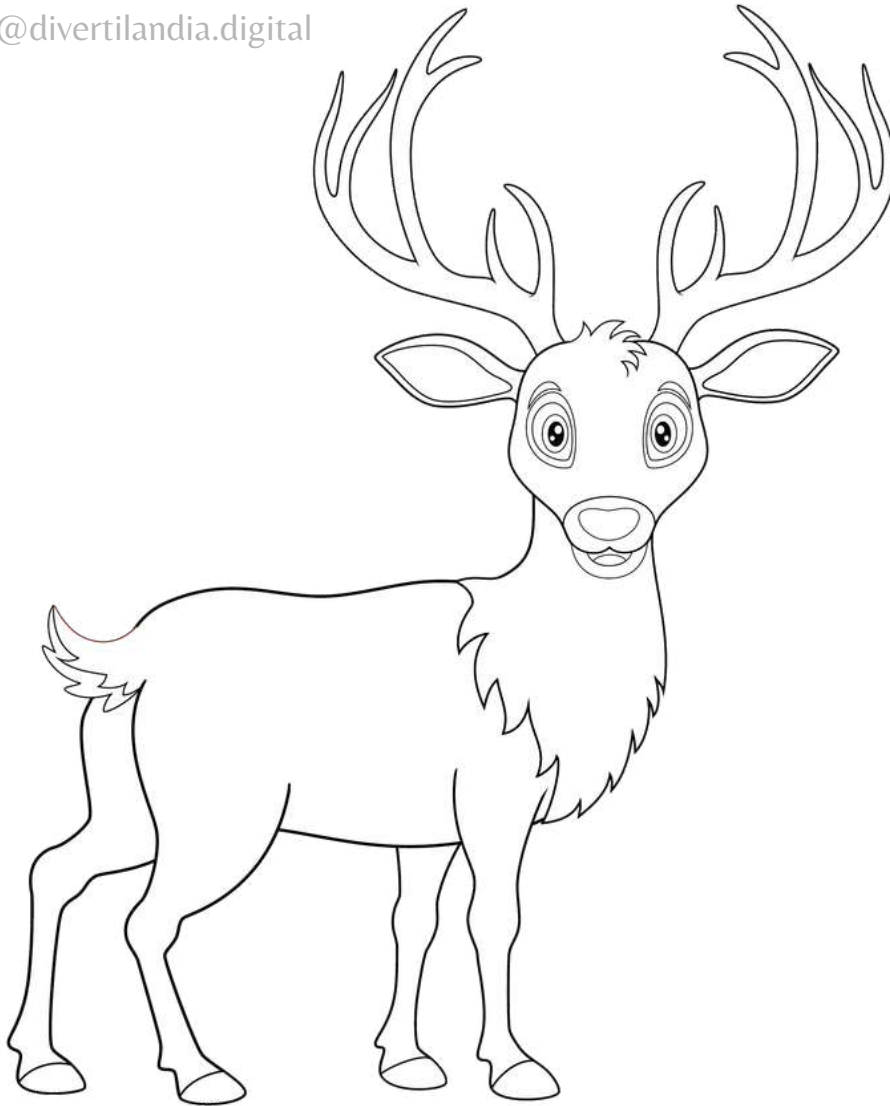

Wapití

X x

@divertilandia.digital

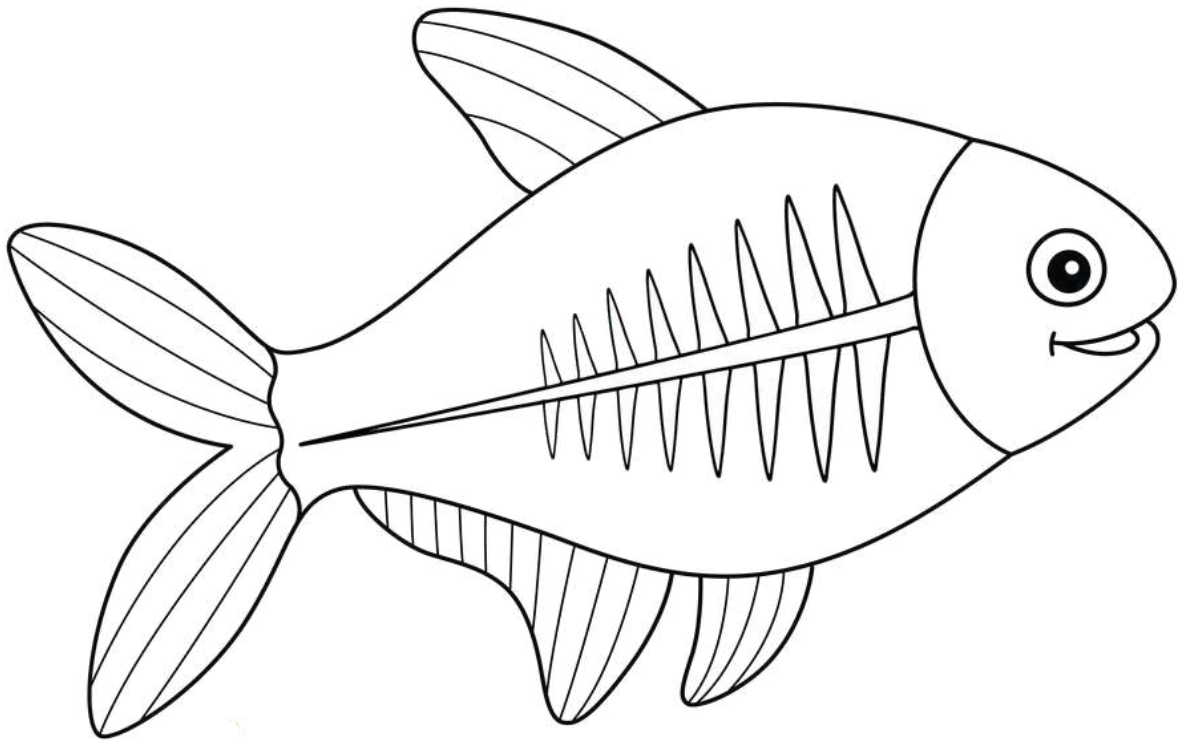

pez de rayos X

Y y

@divertilandia.digital

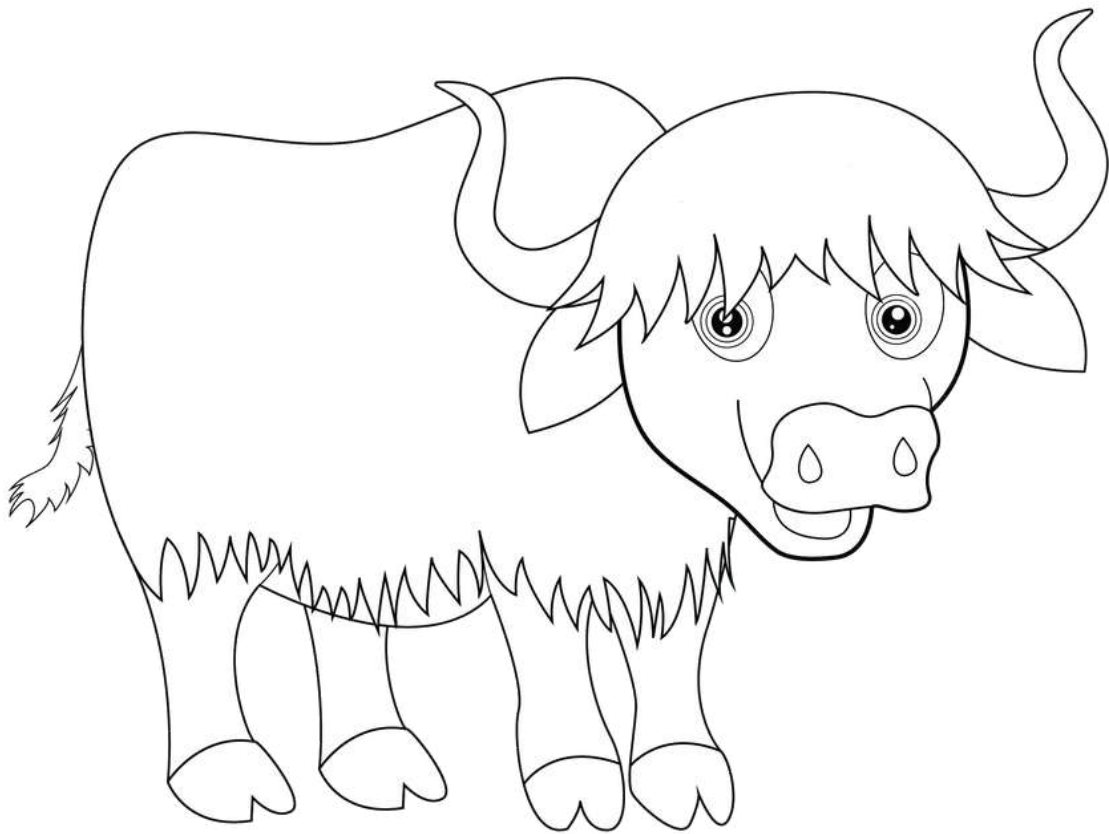

YAK

Zz

@divertilandia.digital

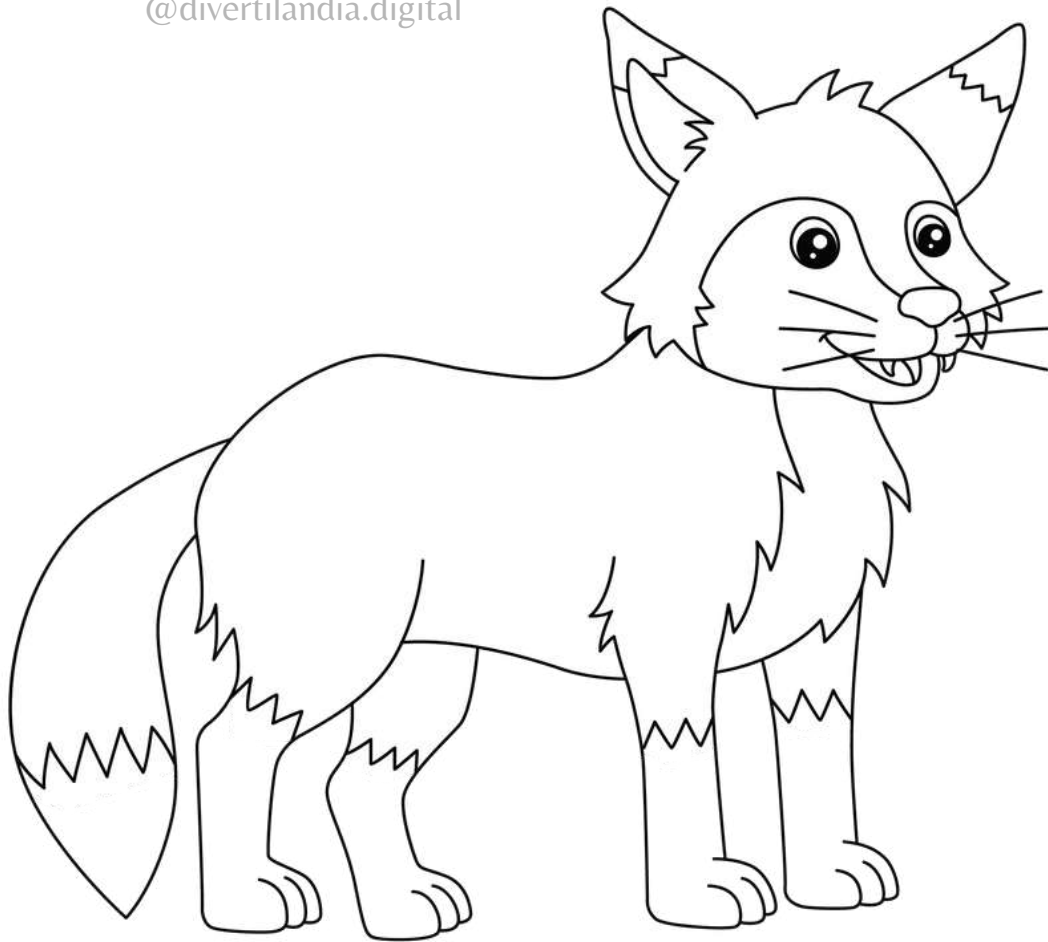

Zorro

## COLOREA LAS CONSONANTES

O i T a

d G f N

@divertilandia.digital

M u r e





## ENCUENTRA LAS CONSONANTES

Di el nombre del objeto y colorea la letra con la que comienza.

sol

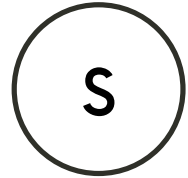
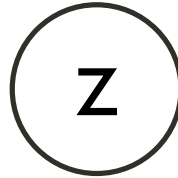
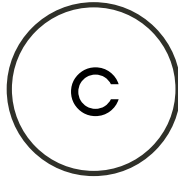
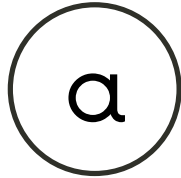
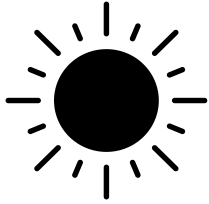

catarina

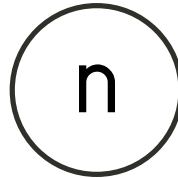
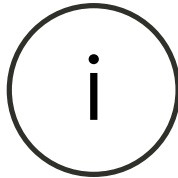
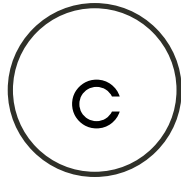
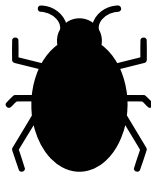

sombrero

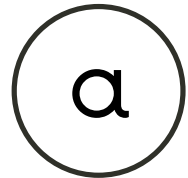
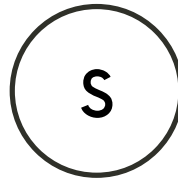
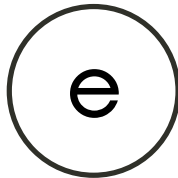
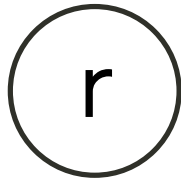
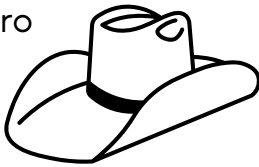

perro

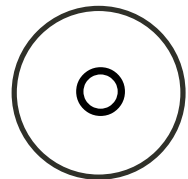
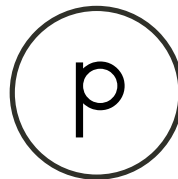
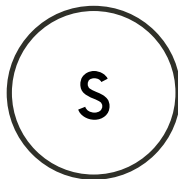
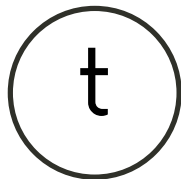
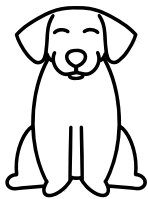

juguete

