

ALPHABET

TRACE AND RECOGNIZE LETTERS



Spanish Workbook

hola!

DIVERTI
LANDIA

@divertilandia.digital

Bilingual

workbook



Name:

Grade:

Age:

Recommendations

@divertilandia.digital

1. Print this booklet in black and white or in color.
2. You can also laminate the pages separately to be able to review the activities many times over.
3. Teach your little one how to hold a pen or pencil properly.
4. Practice together. It's very important for kids to feel your support when learning something new.
5. These exercises are very useful for improving children's Spanish vocabulary as they contain different types of activities tailored to their age.
6. Don't despair. Everything takes time. It will take time, hours of practice, and a lot of determination for your child to acquire the ability to read and write fluently in Spanish.



Learning is fun!

Spanish Workbook

Traza

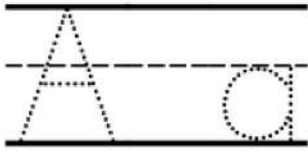

Escribe

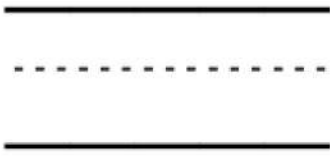

Colorea

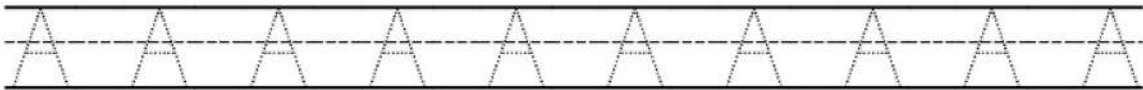
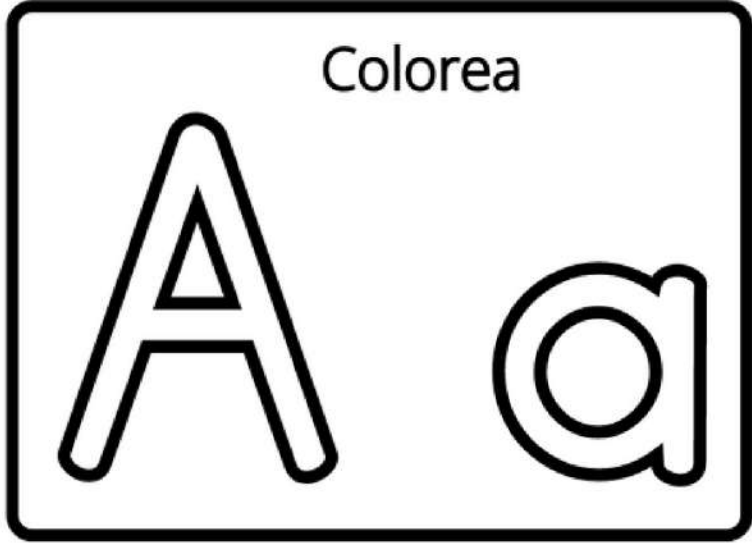

A



a



Spanish Workbook

Traza

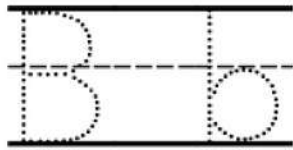

Escribe

Blank handwriting lines for independent practice, consisting of a solid top line, a dashed middle line, and a solid bottom line.

Colorea

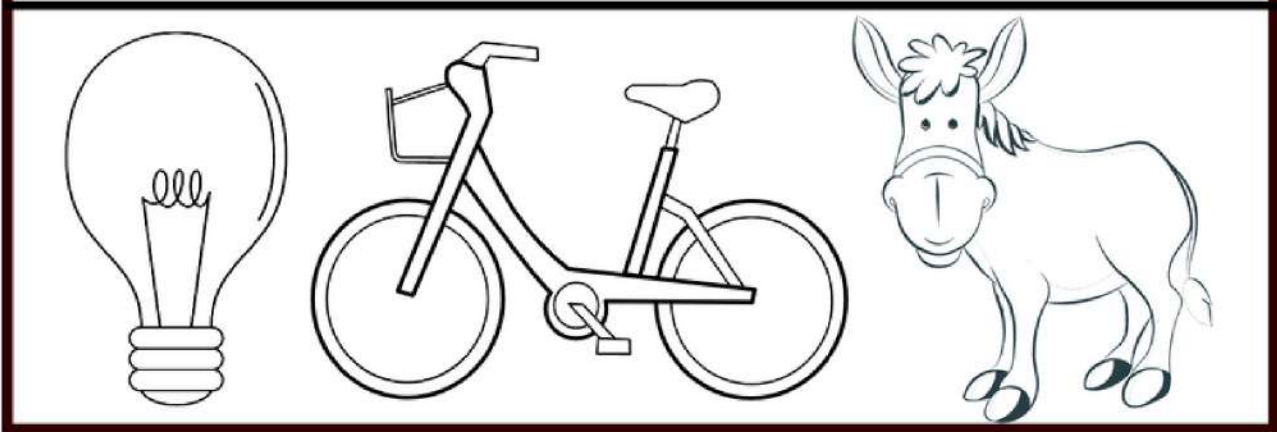
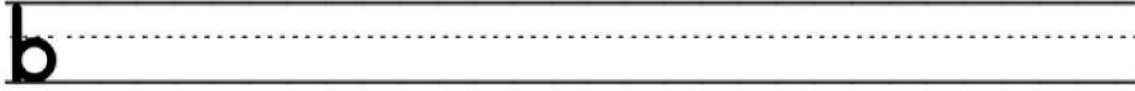
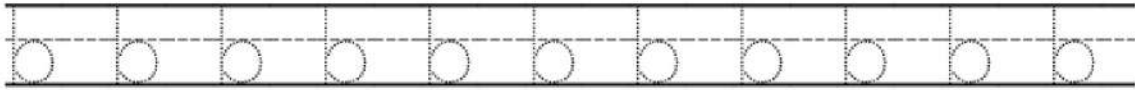
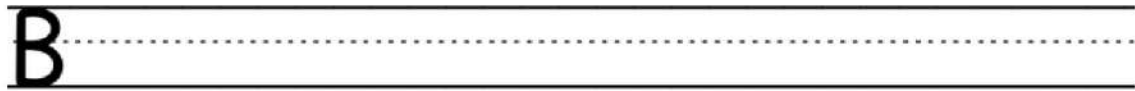
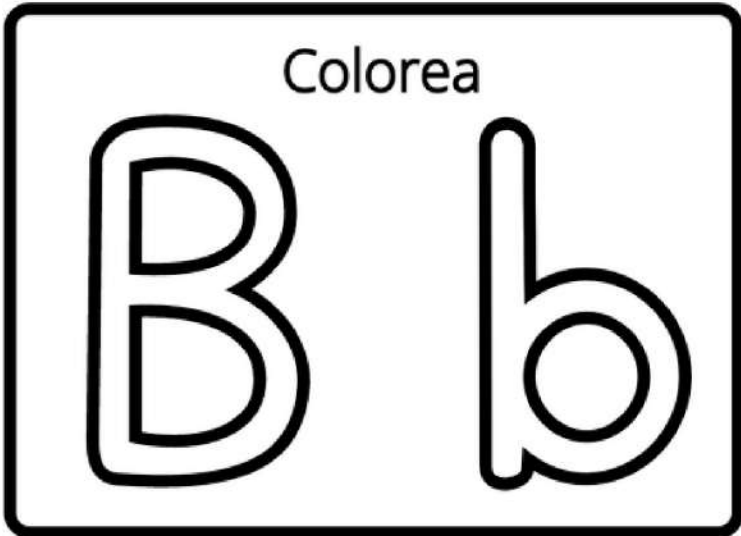

Spanish Workbook

Traza

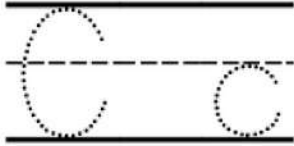

Escribe

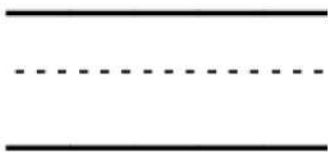

Colorea

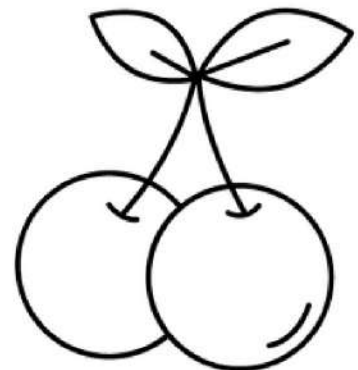
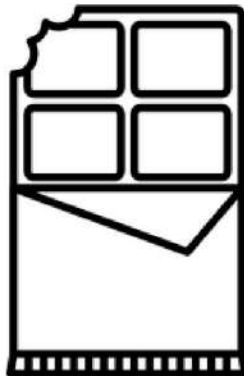
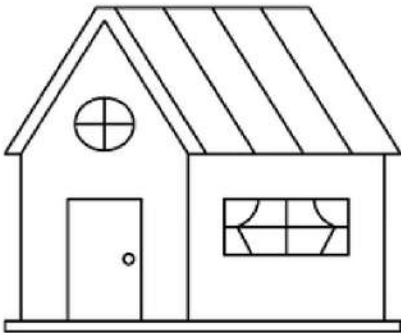
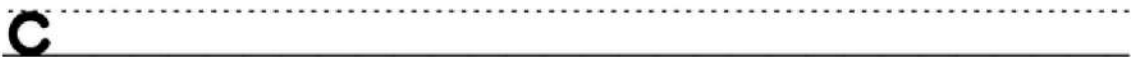
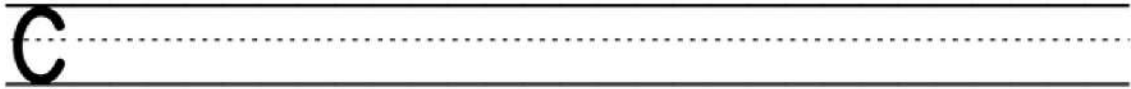
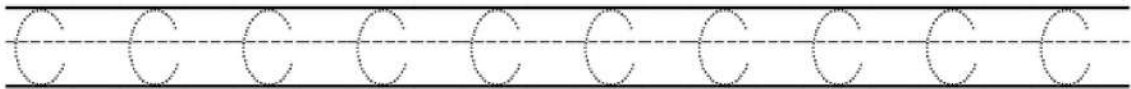
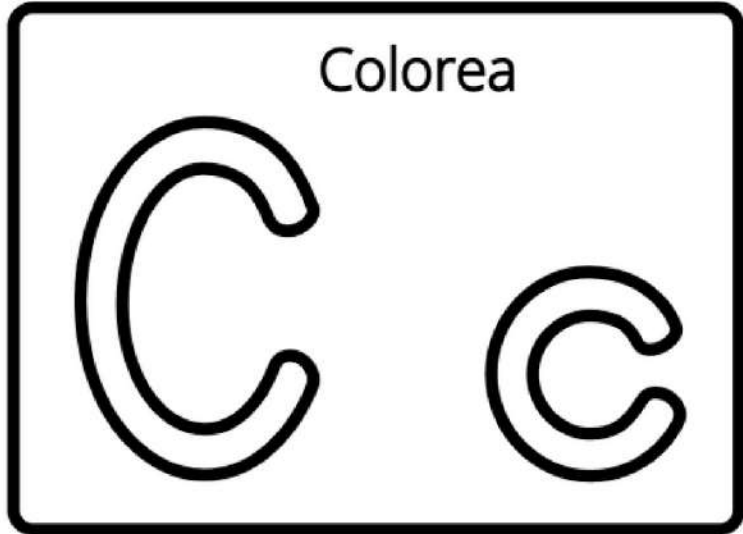

Spanish Workbook

Traza

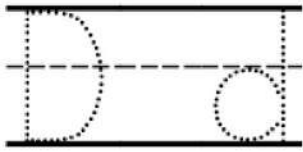

Escribe

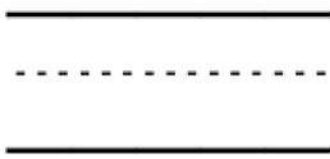

Colorea

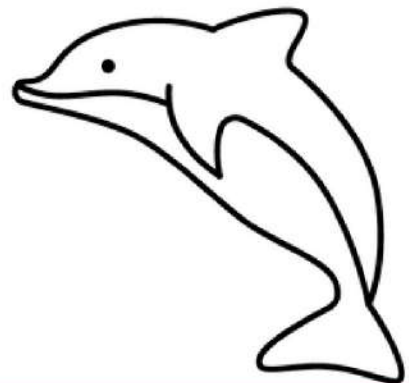
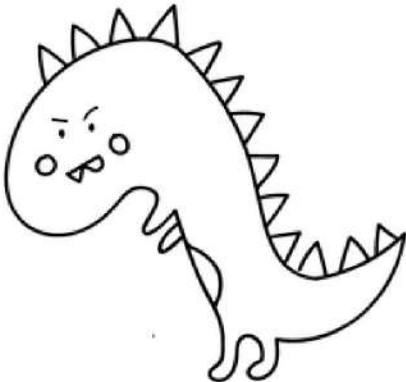
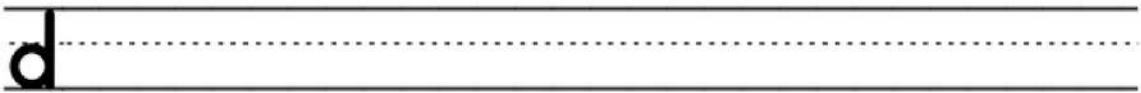
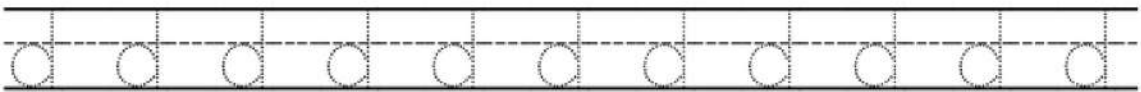
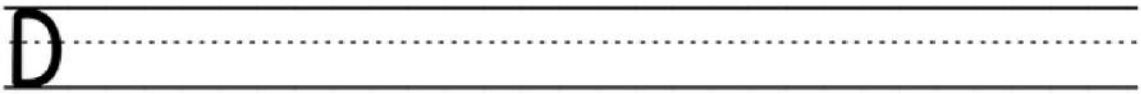
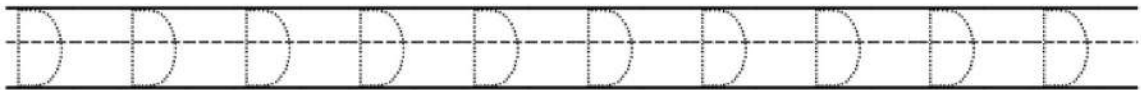
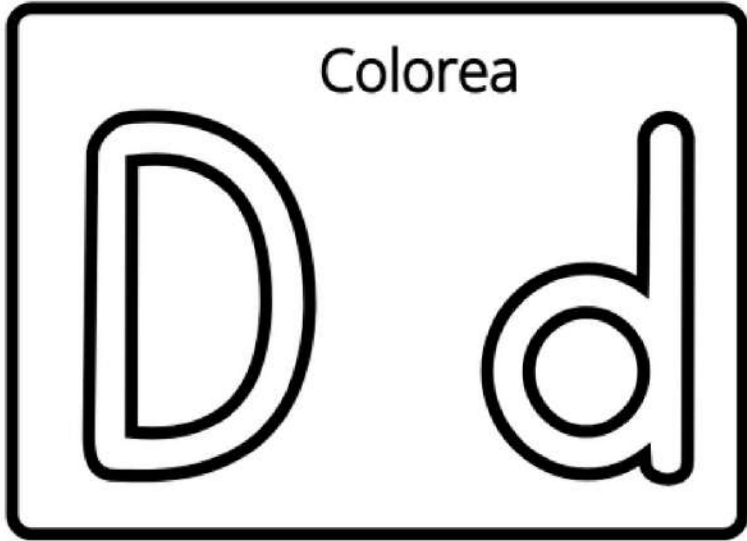

Spanish Workbook

Traza

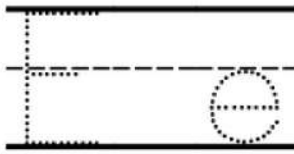

Escribe

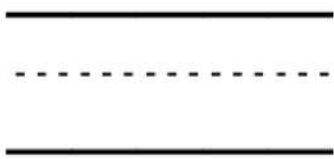

Colorea

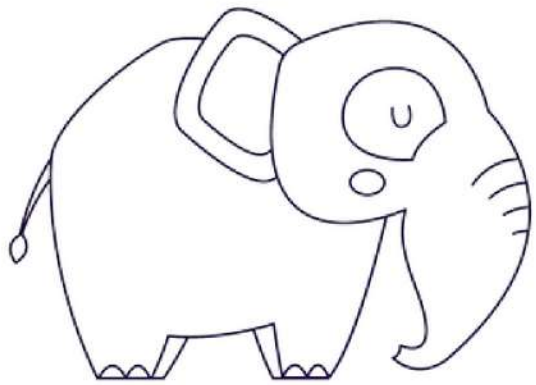
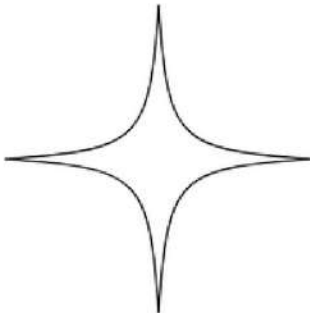
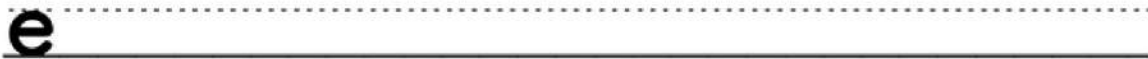
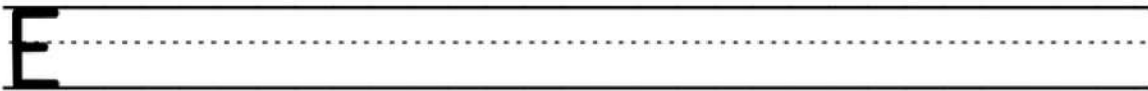
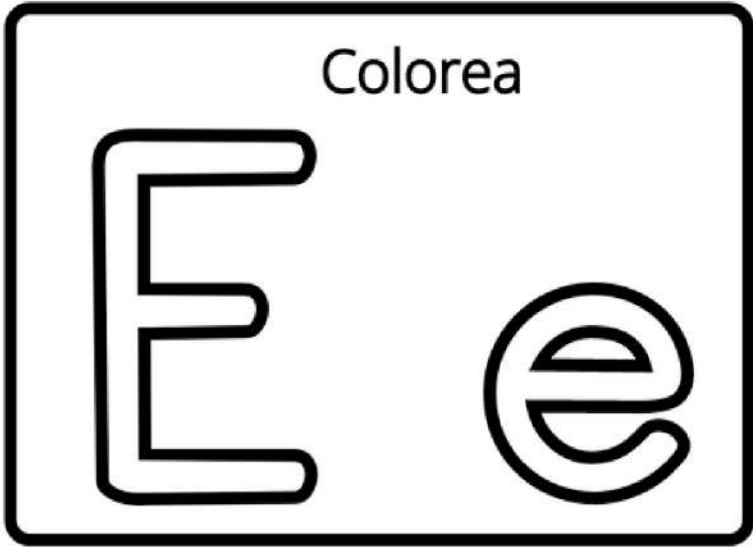

Spanish Workbook

Traza

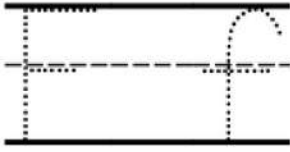

Escribe

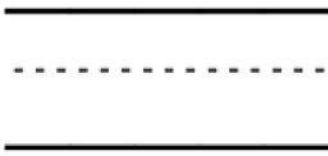

Colorea

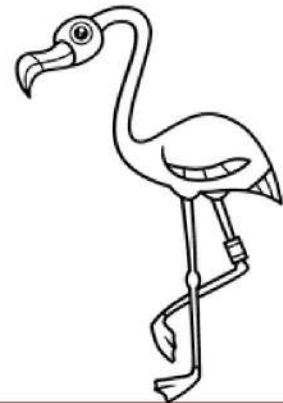
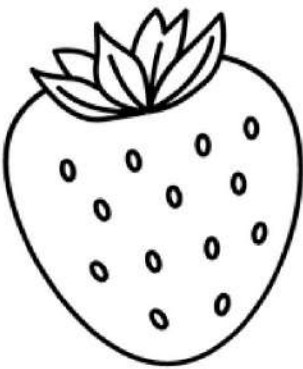
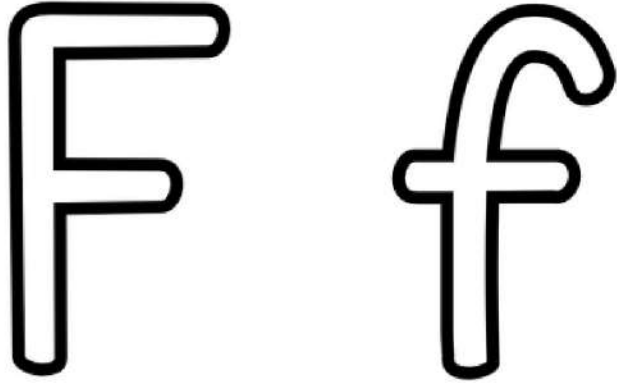

Spanish Workbook

Traza

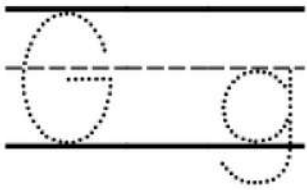

Escribe

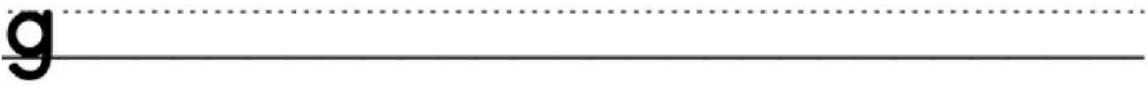
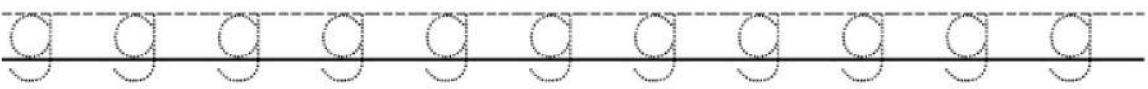
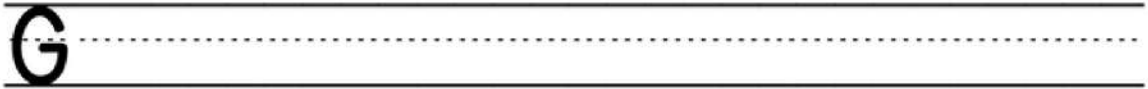
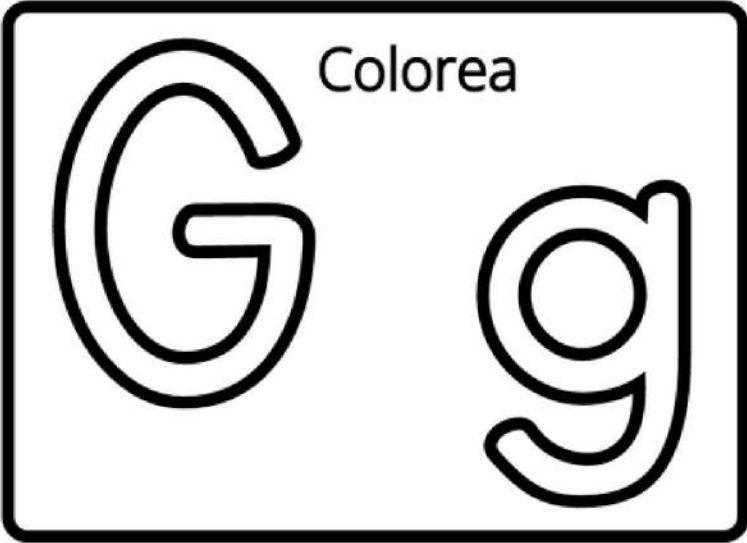
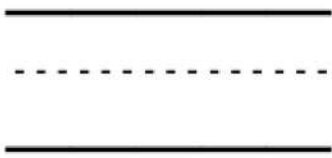

Spanish Workbook

Traza

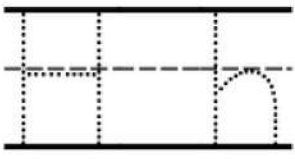

Escribe

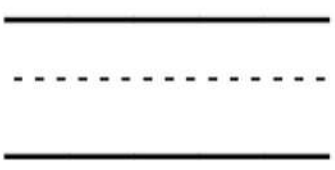

Colorea

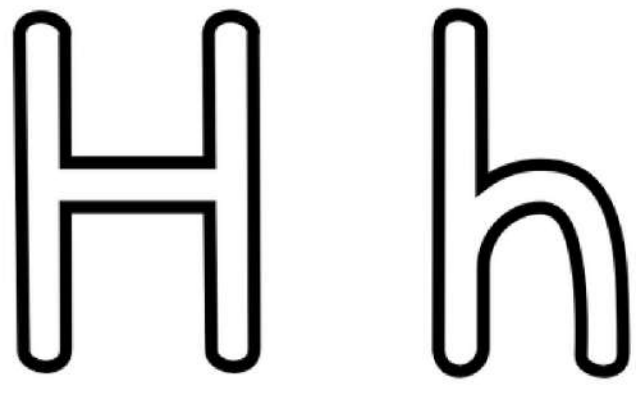

H

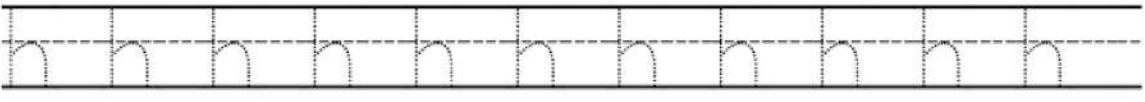

h

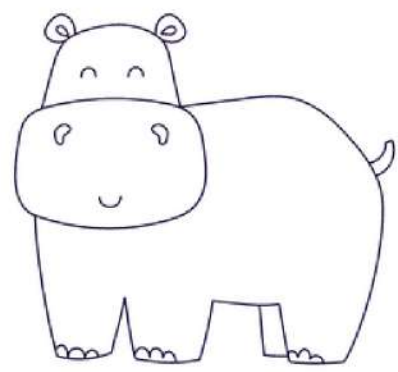
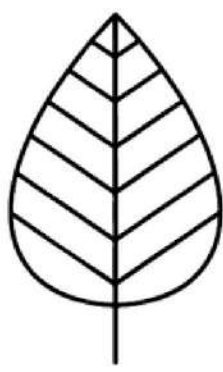

Spanish Workbook

Traza

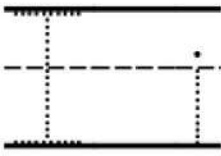

Escribe

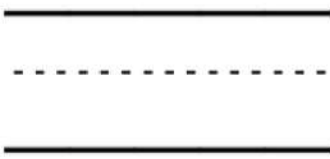

Colorea

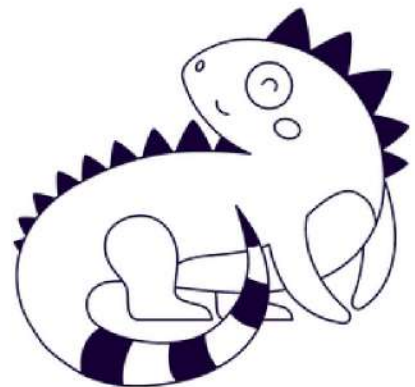
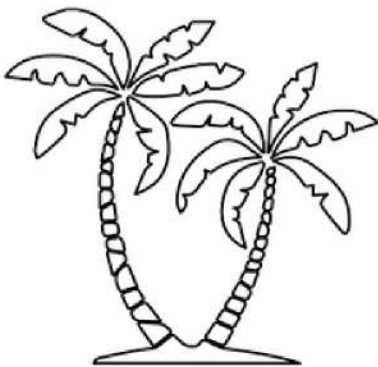
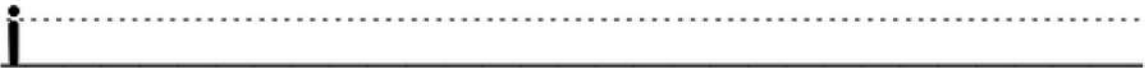
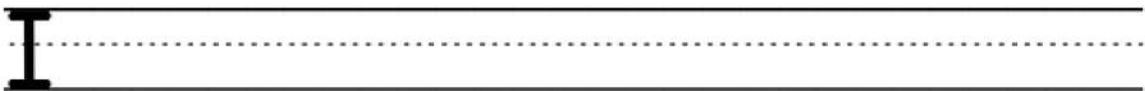
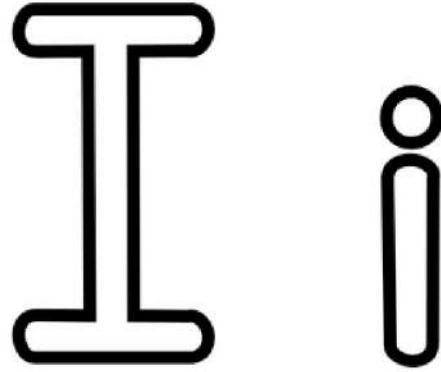

Spanish Workbook

Traza

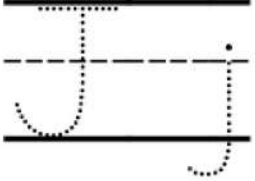

Escribe

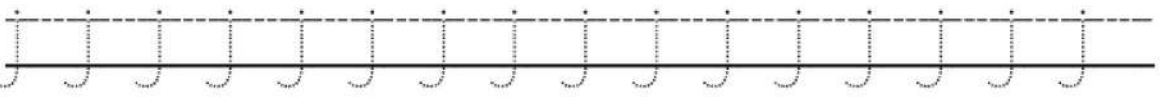
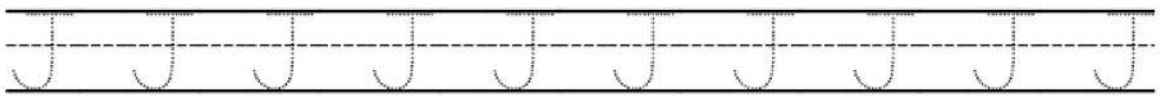
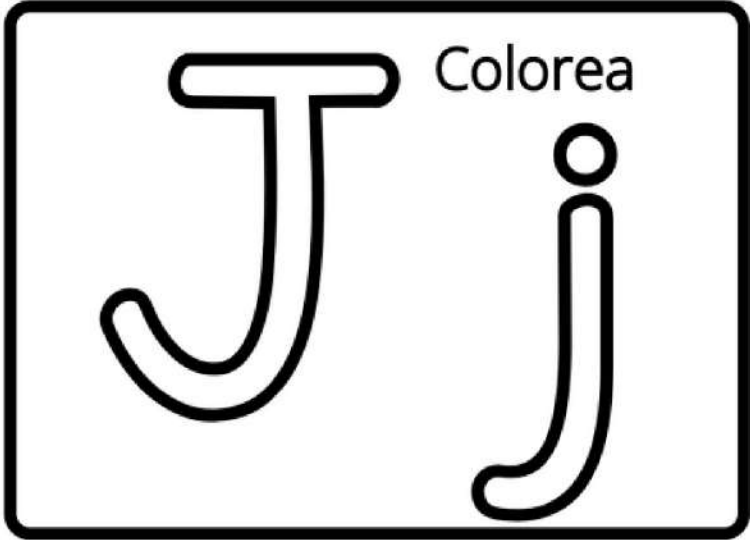
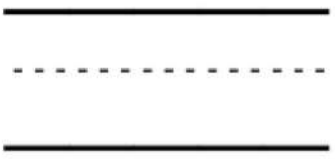

Spanish Workbook

Traza

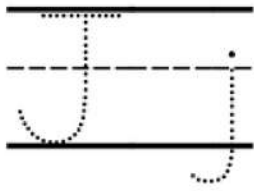

Escribe

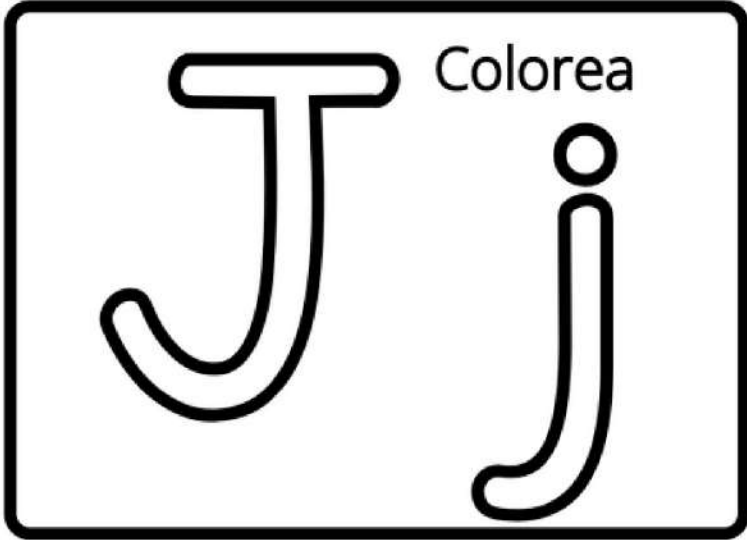
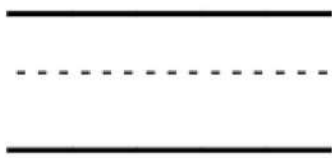

J

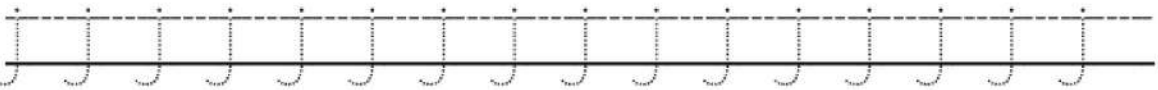

j

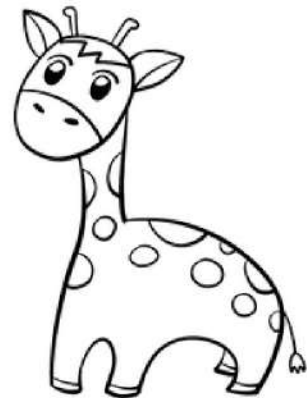

Spanish Workbook

Traza

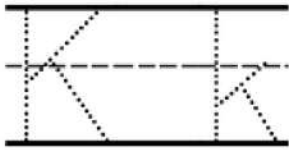

Escribe

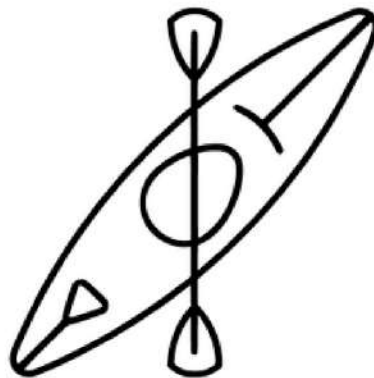
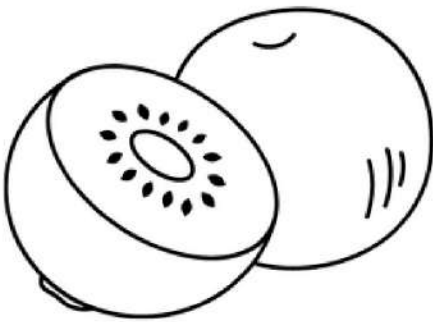
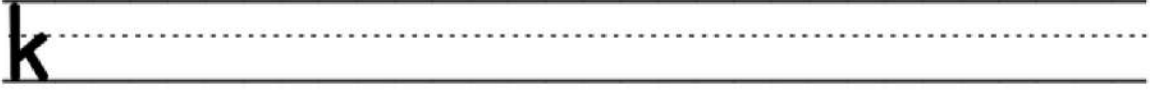
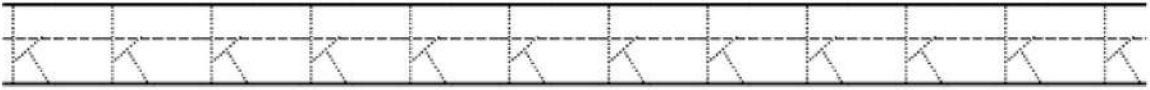
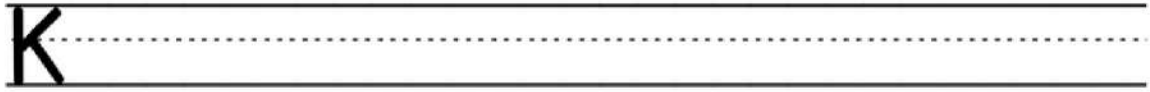
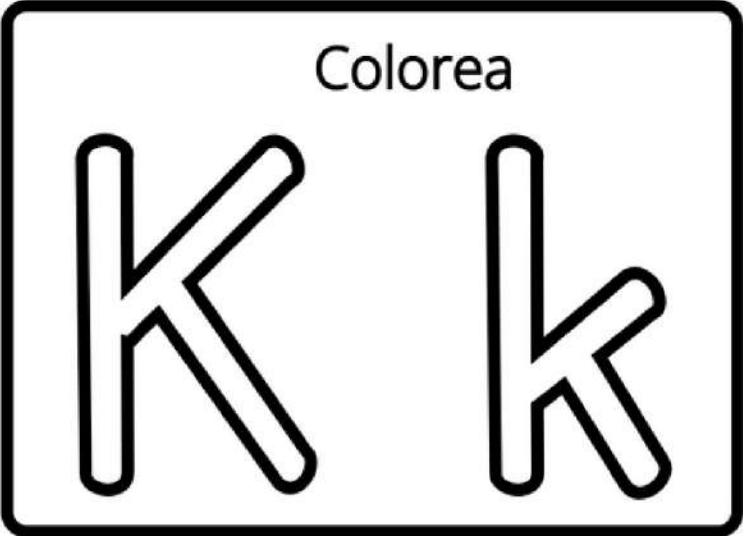
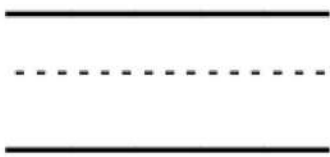

Spanish Workbook

Traza

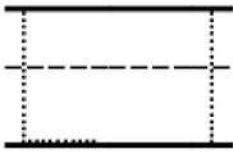

Escribe

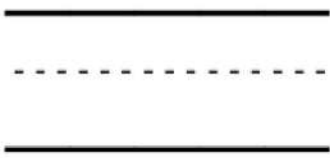

Colorea

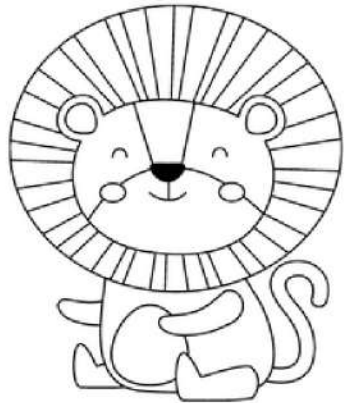
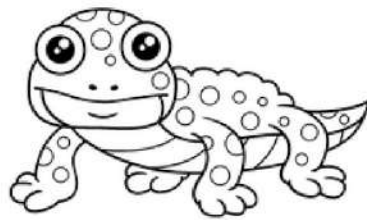
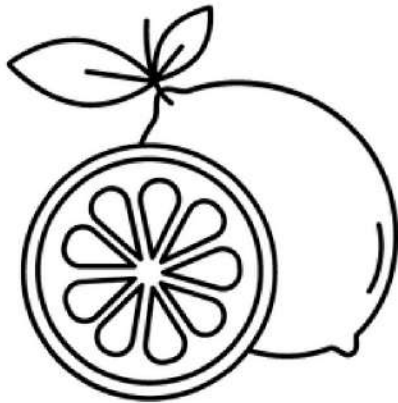
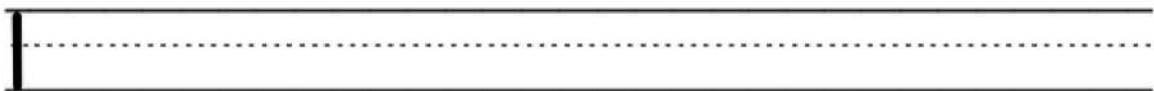
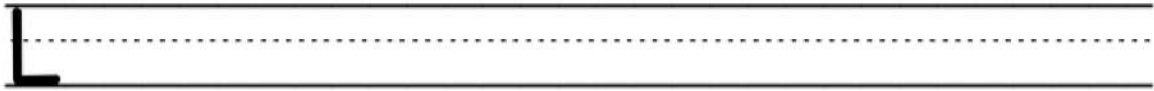
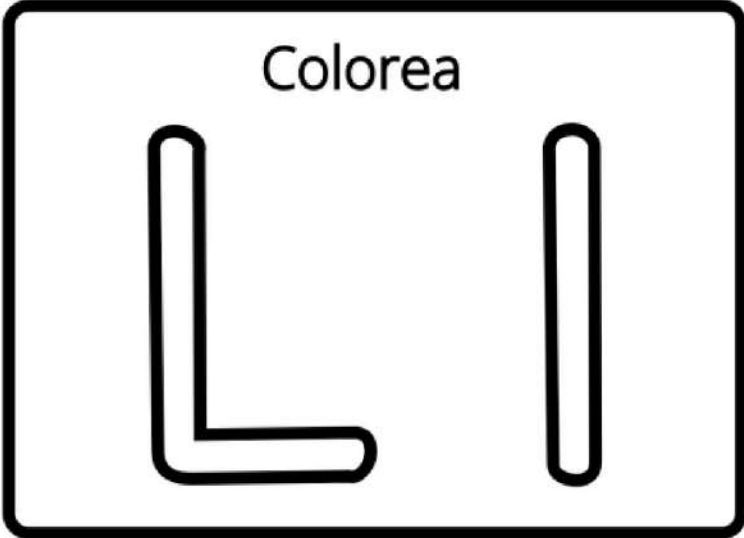

Spanish Workbook

Traza

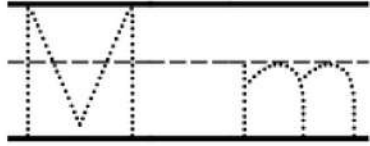

Escribe

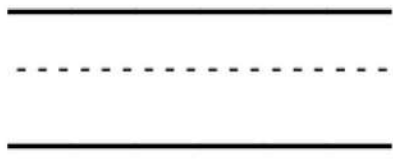

Colorea

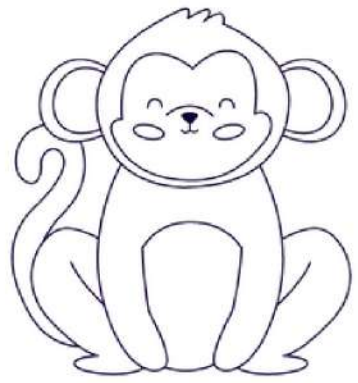
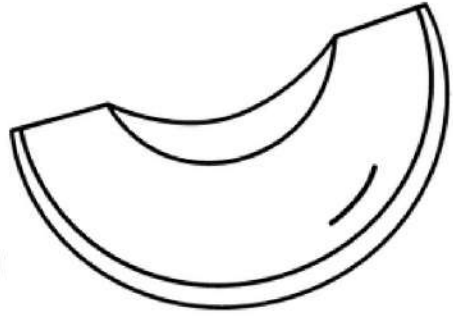
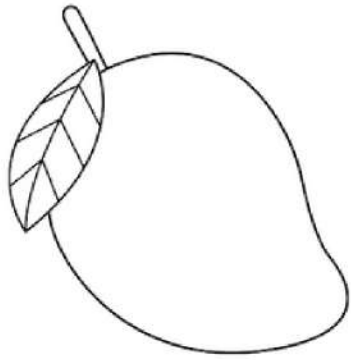
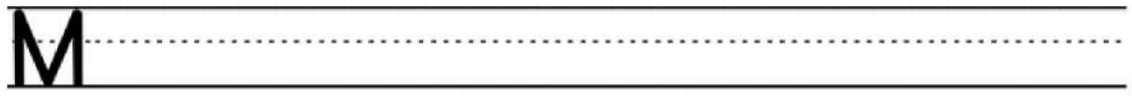
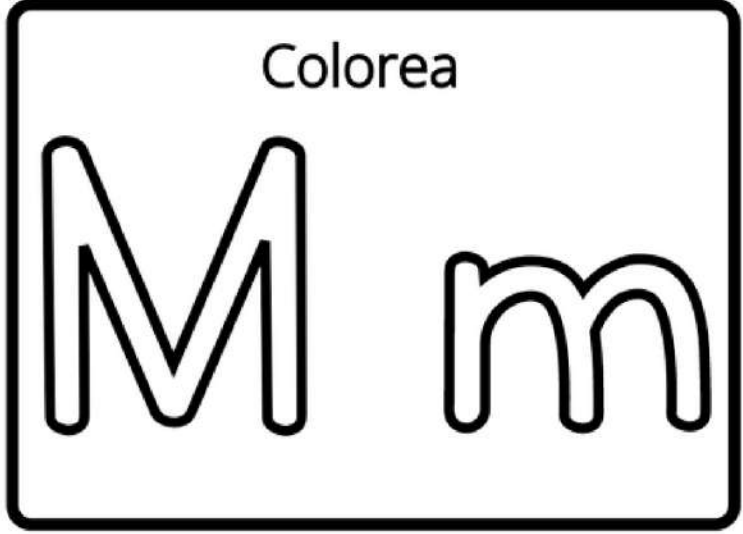

Spanish Workbook

Traza

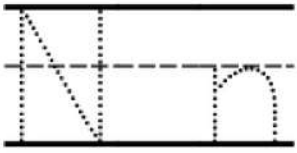

Escribe

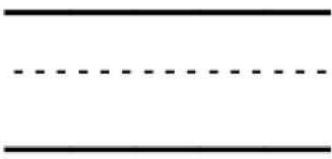

Colorea

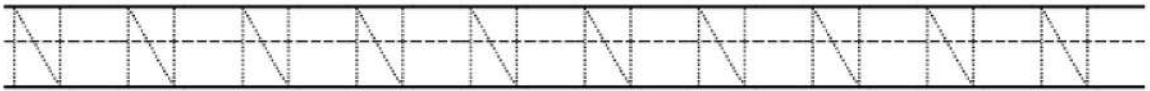
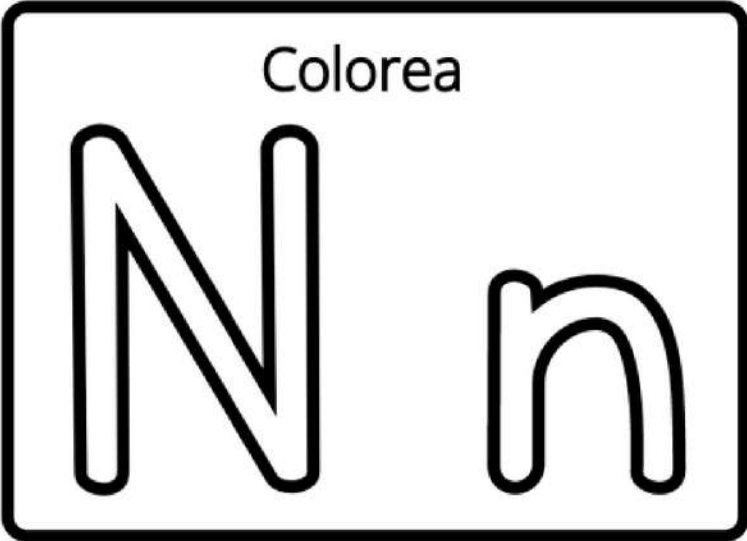

N



n

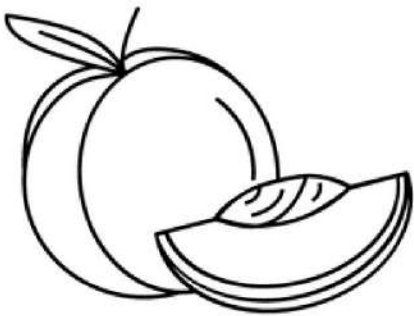

Spanish Workbook

Traza

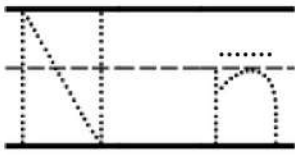

Escribe

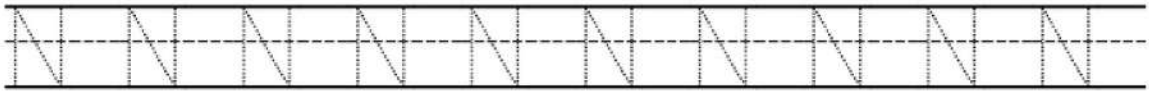
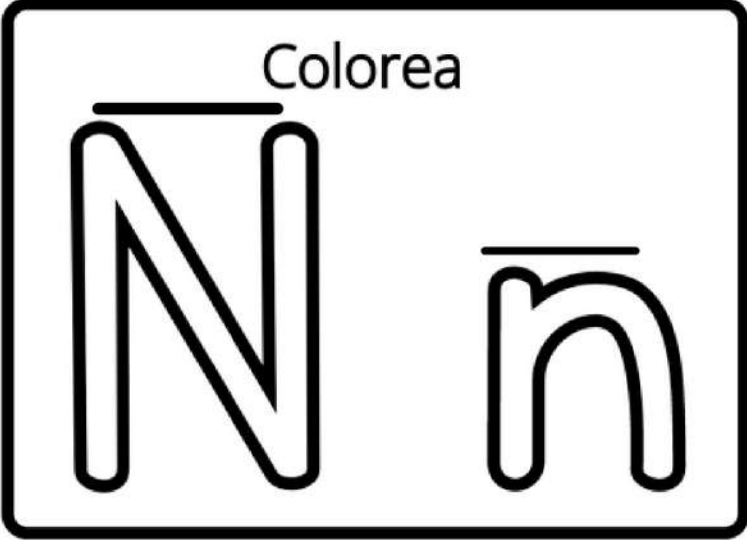
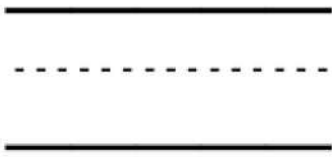

N



n

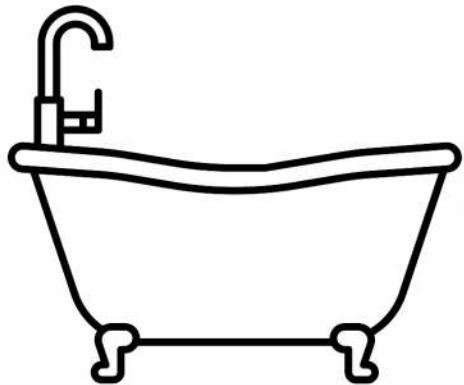
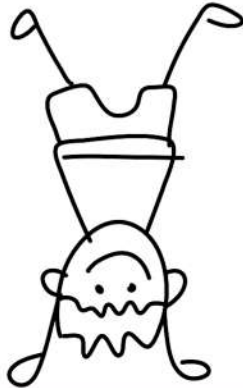

Spanish Workbook

Traza

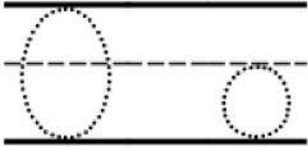

Escribe

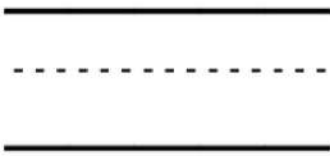

Colorea

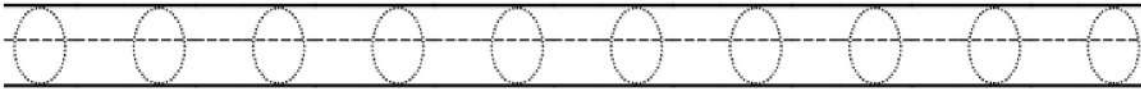
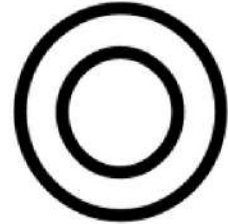
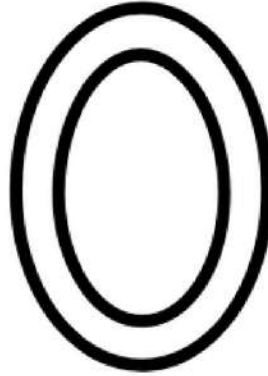

O

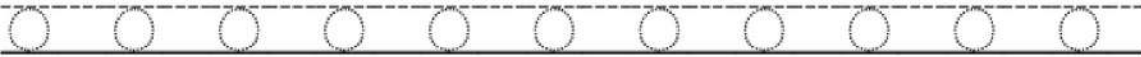

o

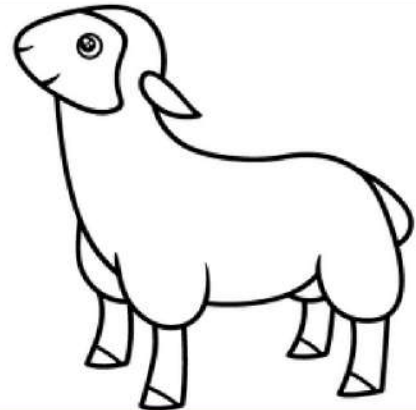

Spanish Workbook

Traza

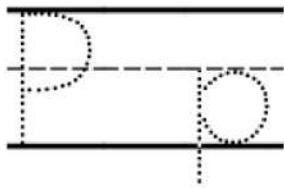

Escribe

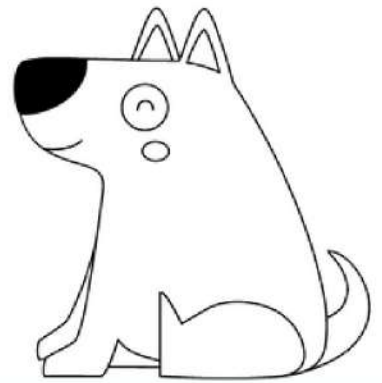
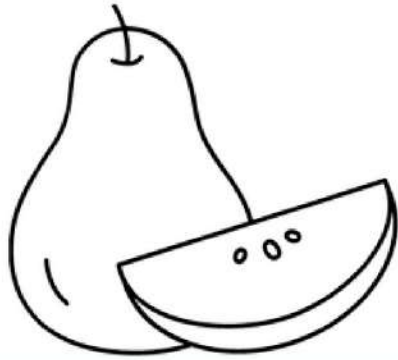
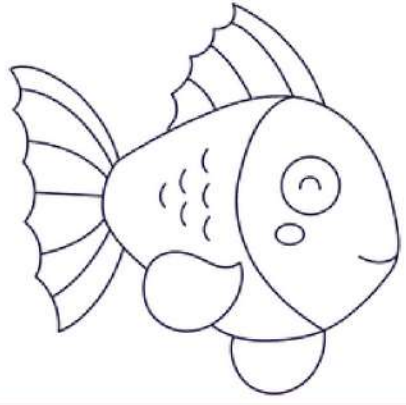
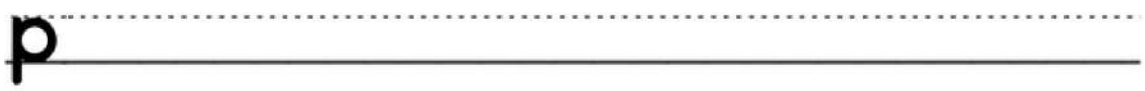
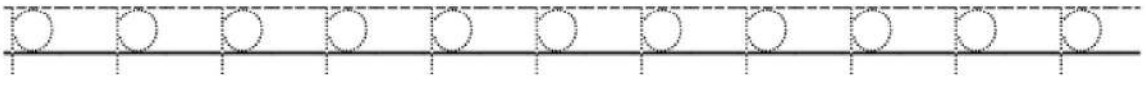
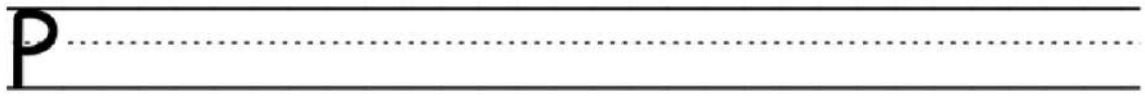
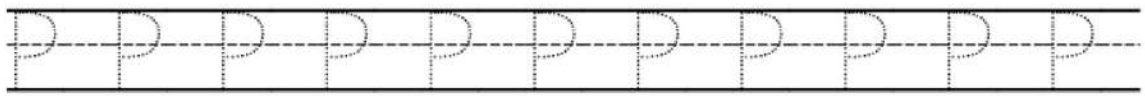
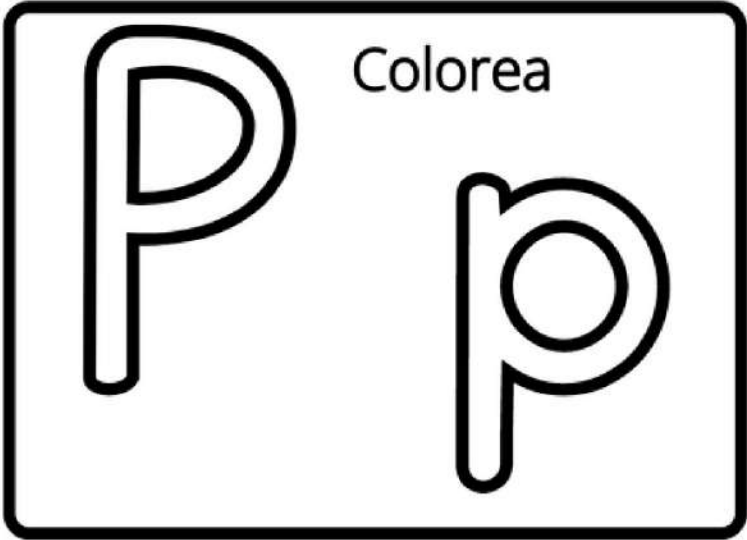
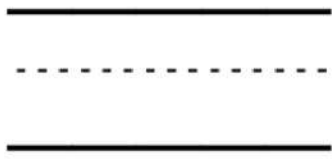

Spanish Workbook

Traza

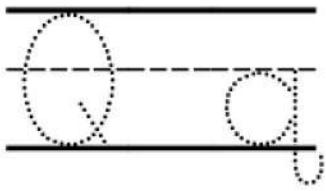

Escribe

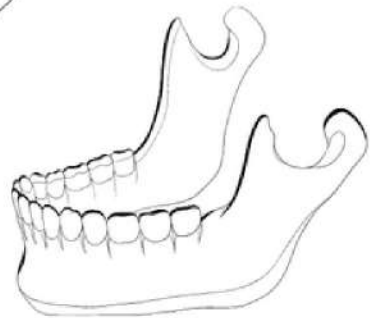
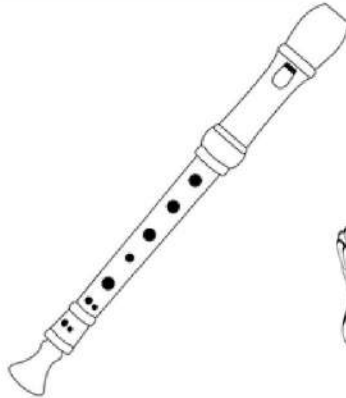
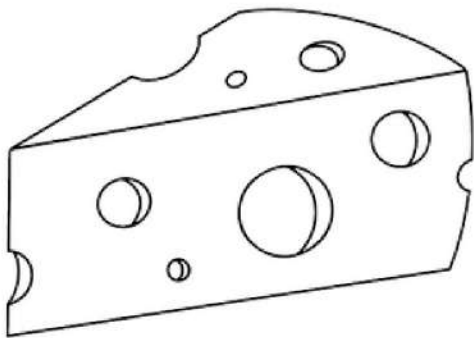
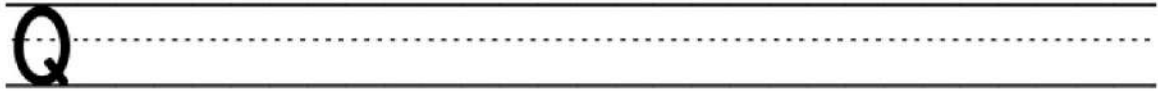
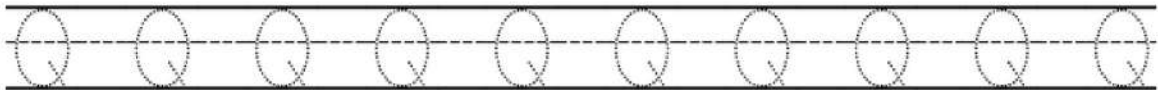
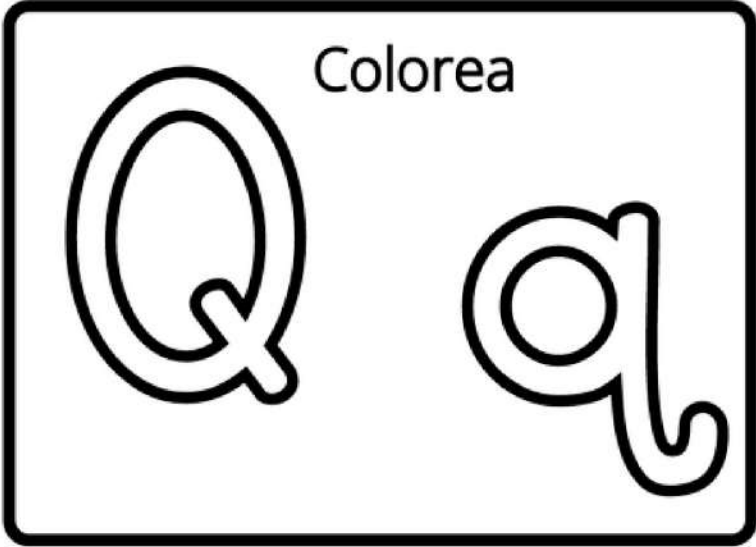
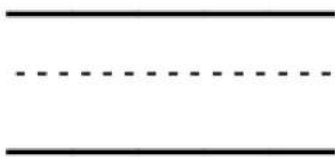

Spanish Workbook

Traza

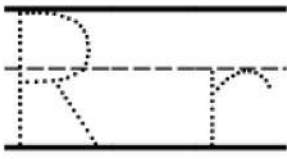

Escribe

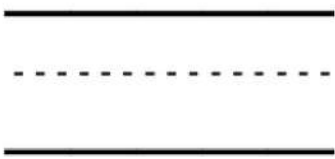

Colorea

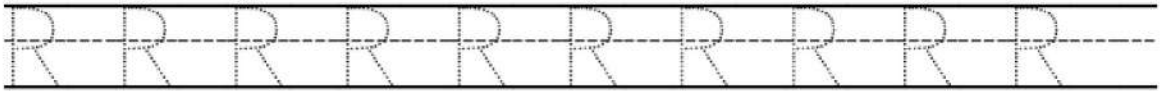
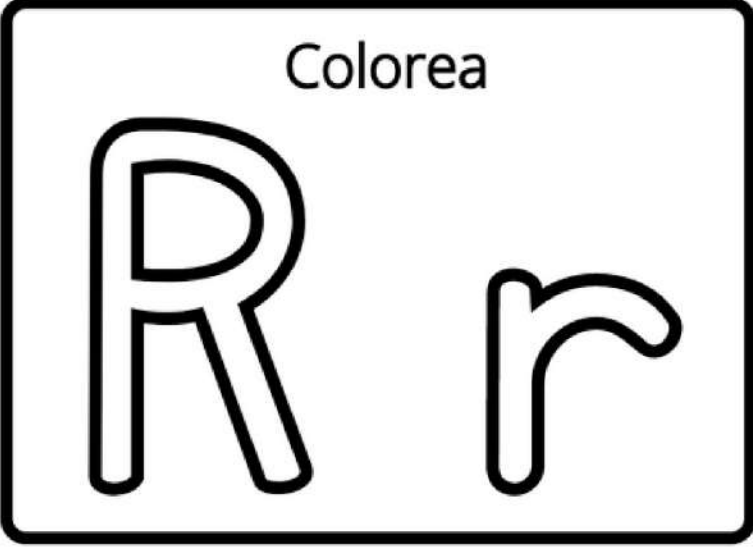

R

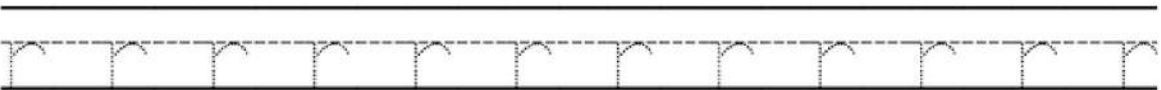

r

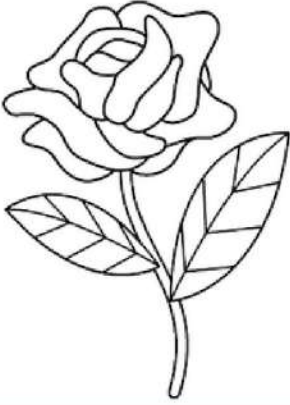
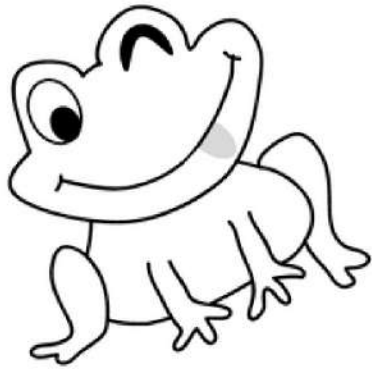

Spanish Workbook

Traza

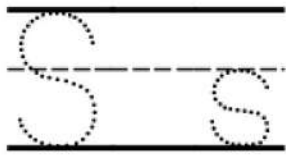

Escribe

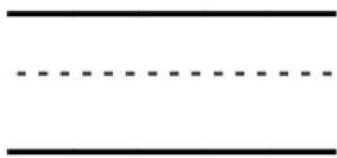

Colorea

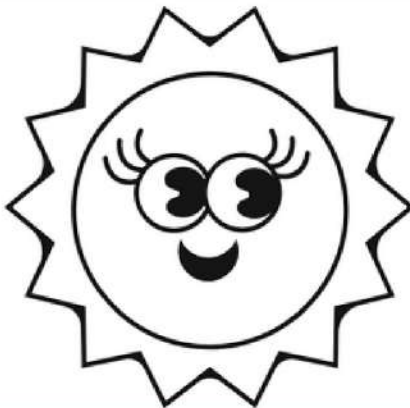
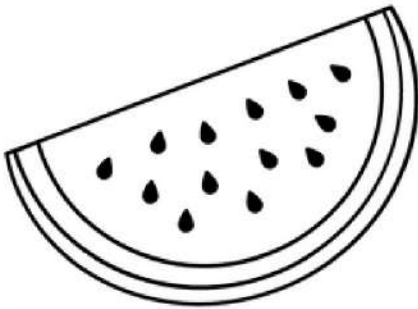
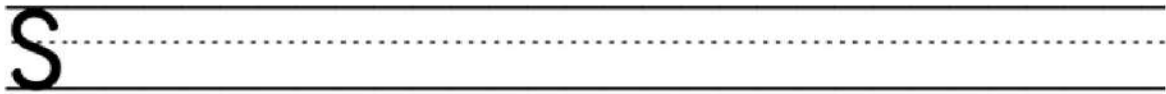
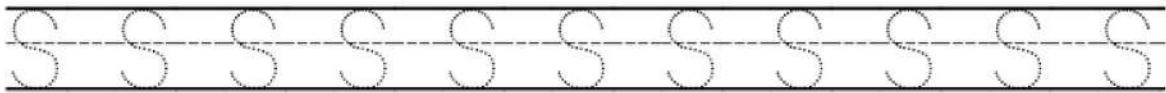
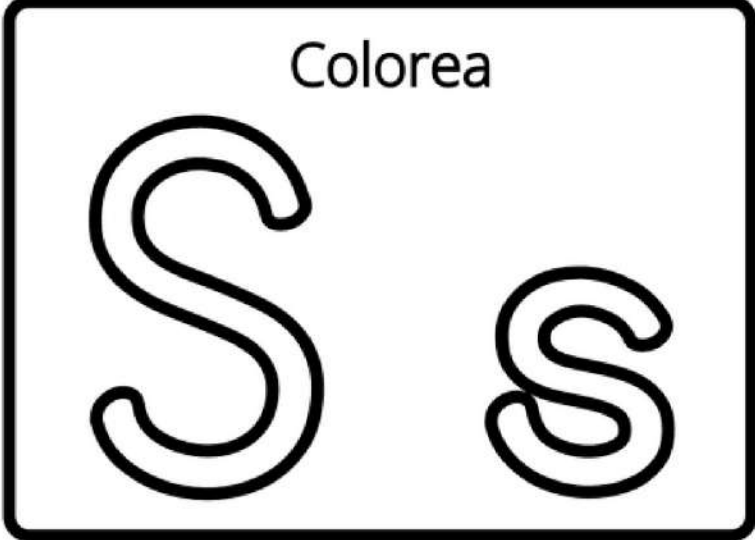

Spanish Workbook

Traza



Escribe

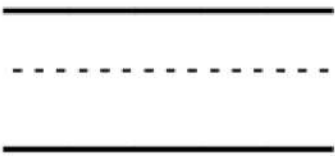

Colorea

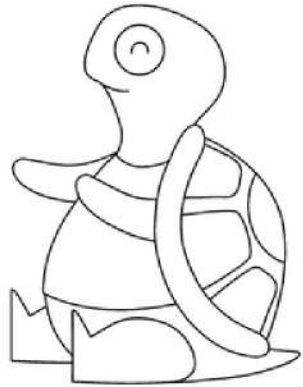
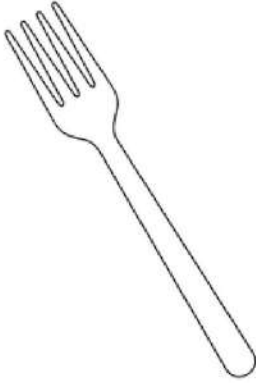
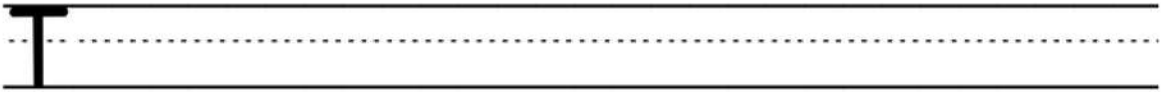
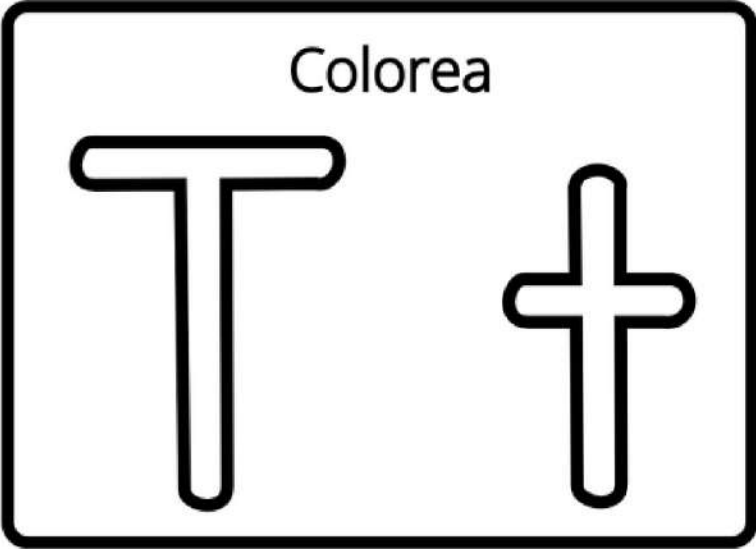

Spanish Workbook

Traza

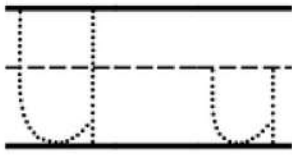

Escribe

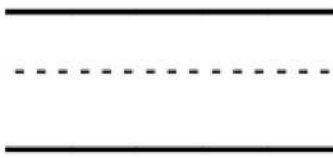

Colorea

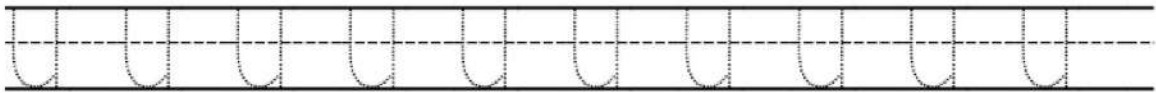
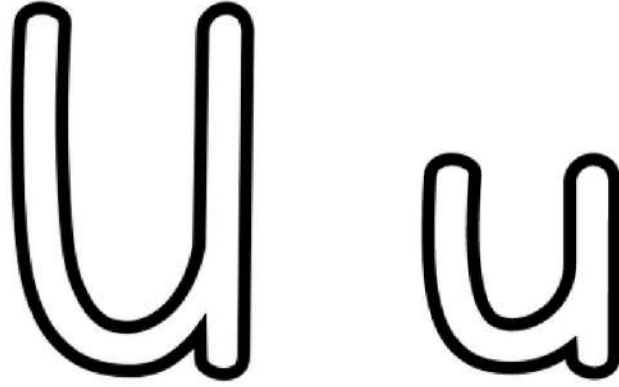

U



u

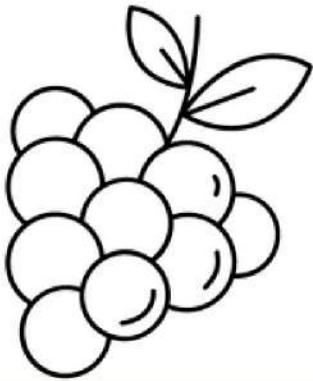

Spanish Workbook

Traza

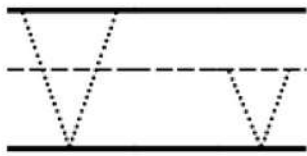

Escribe

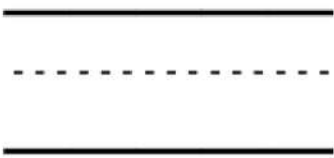

Colorea

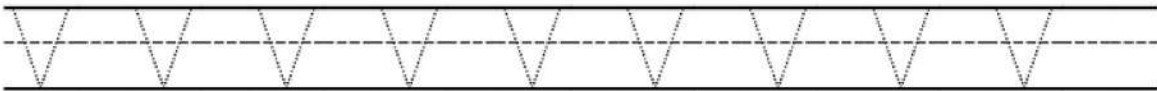
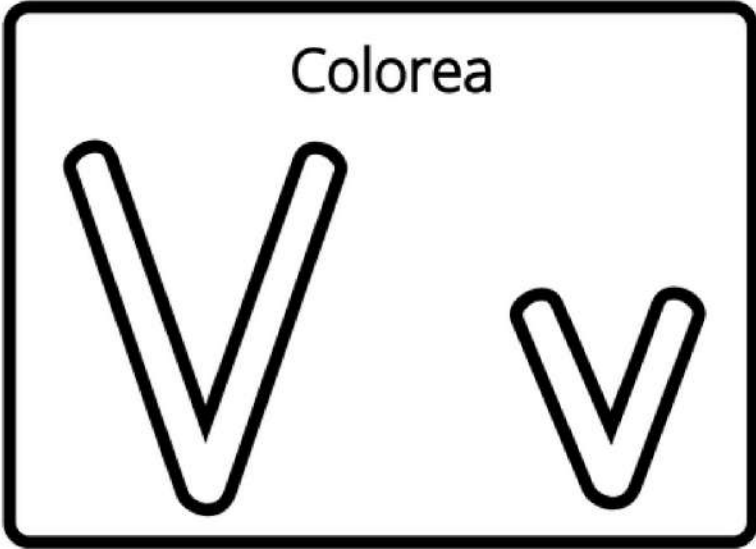

V

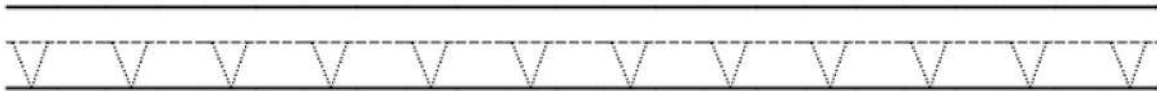

v

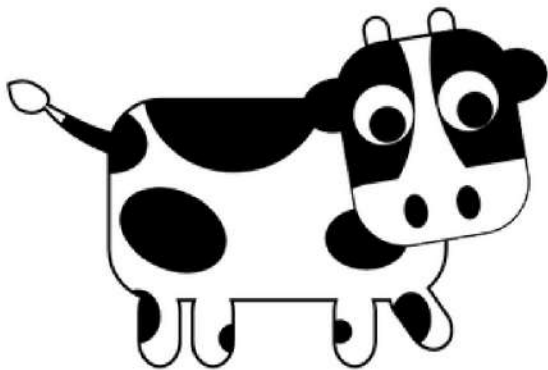

Spanish Workbook

Traza

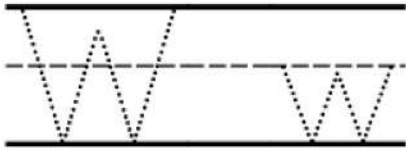

Escribe

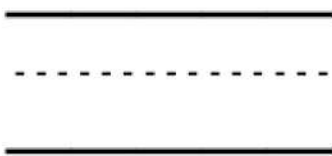

Colorea

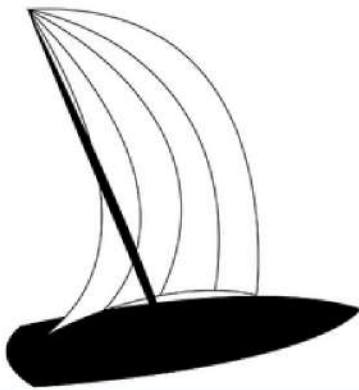
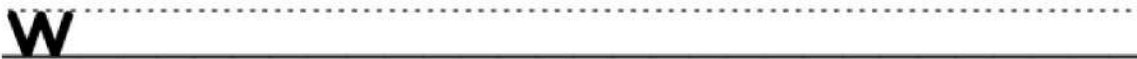
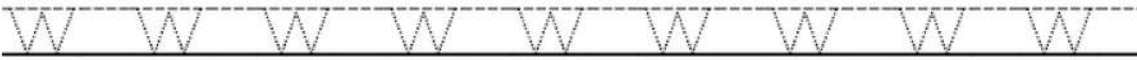
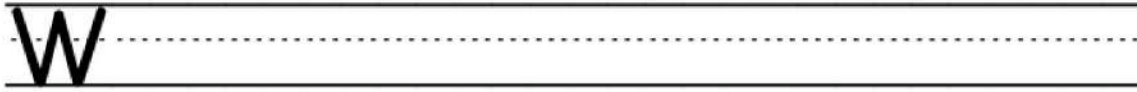
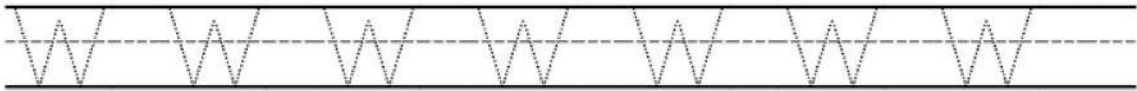

Spanish Workbook

Traza

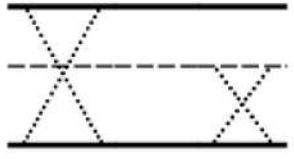

Escribe

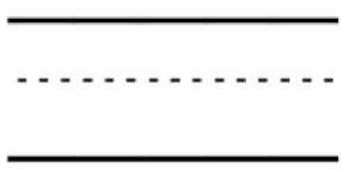

Colorea

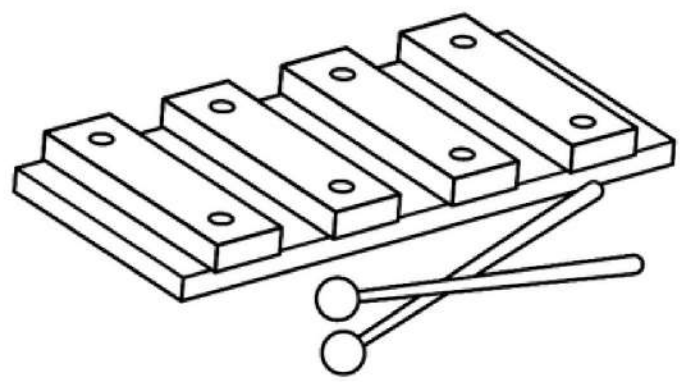
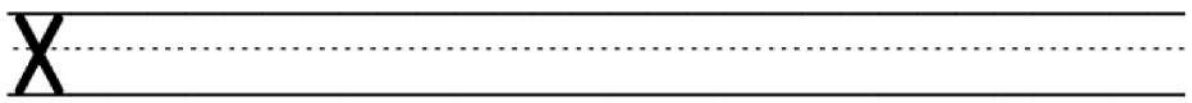
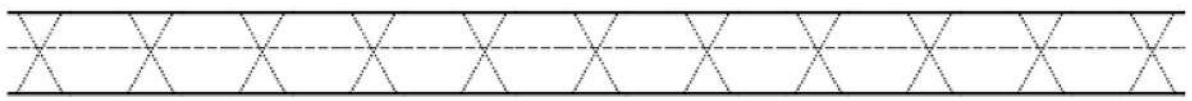
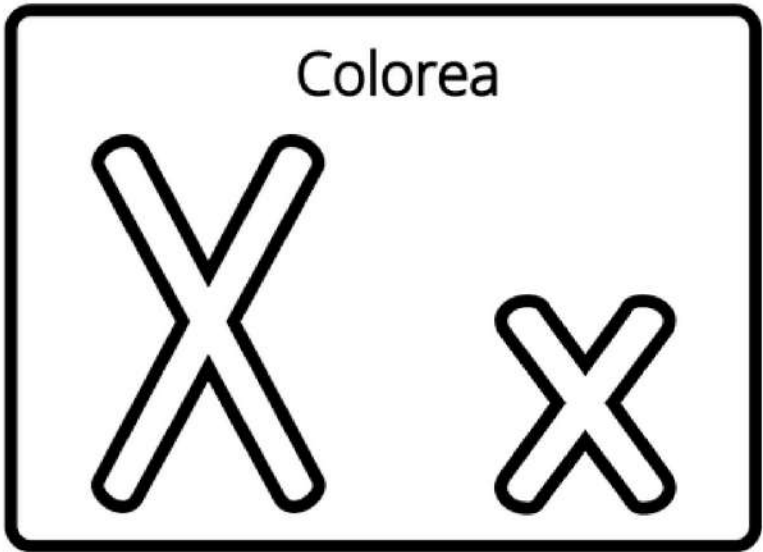

Spanish Workbook

Traza

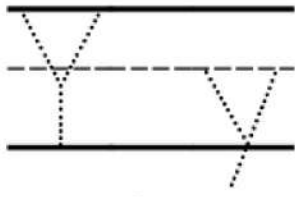

Escribe

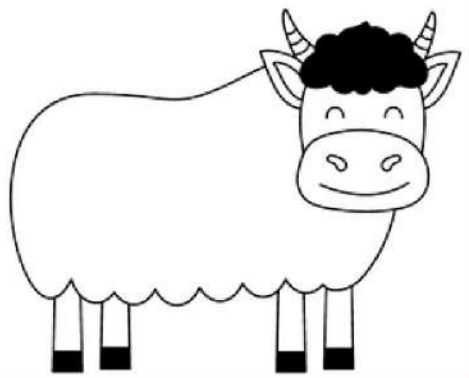
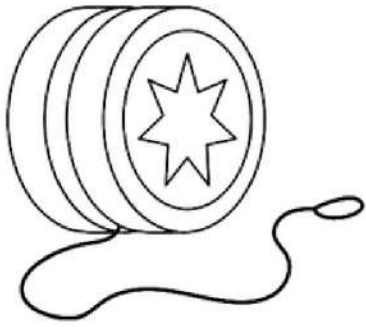
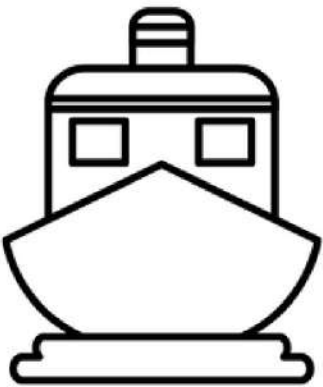
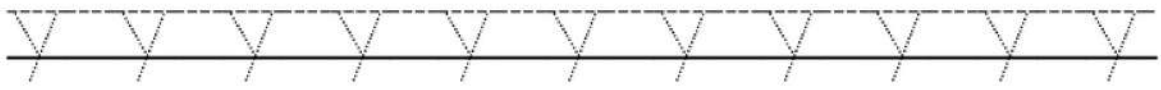
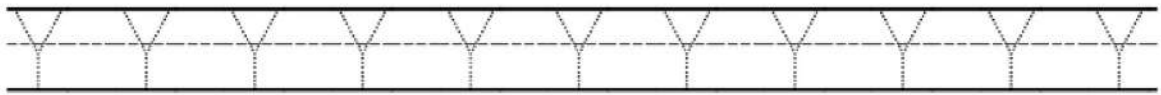
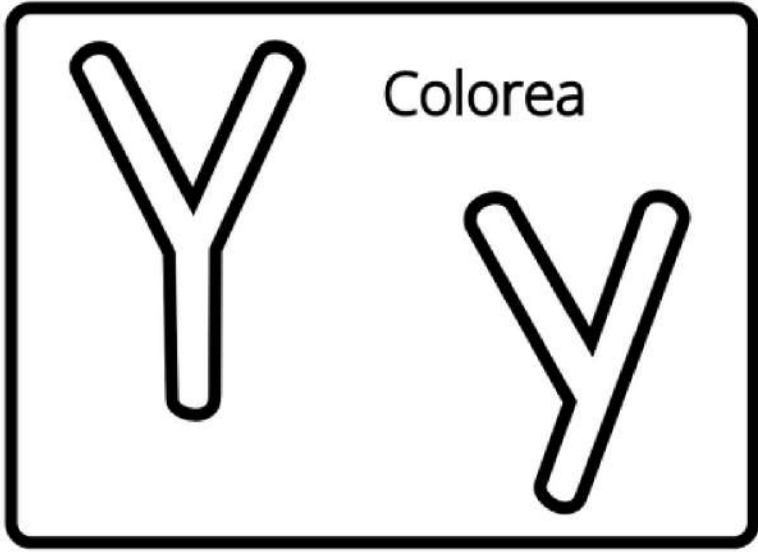
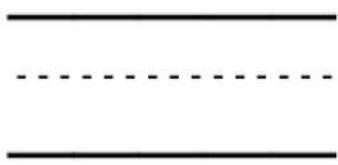

Spanish Workbook

Traza

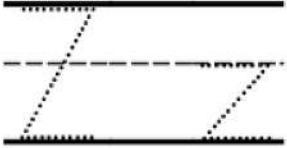

Escribe

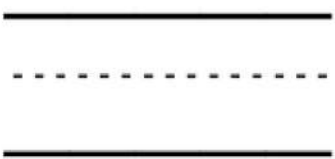

Colorea

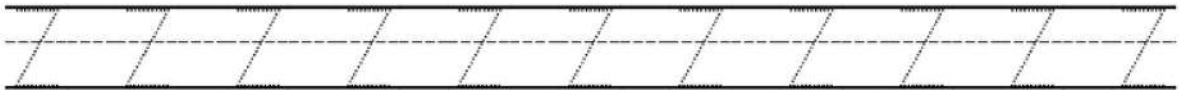
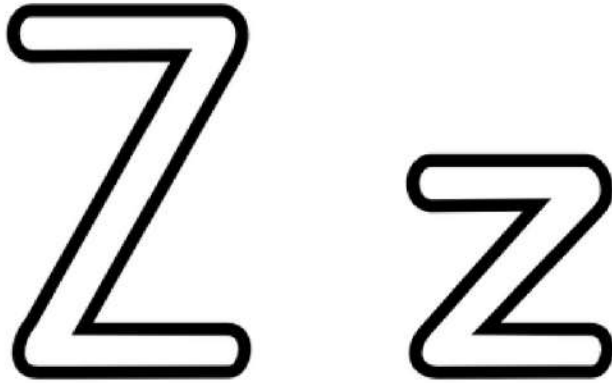

Z



z

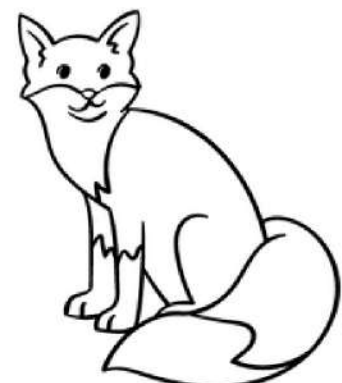

Write the names of the animals in english

A a



Ardilla

(english name)

Write the names of the animals in english

Bb

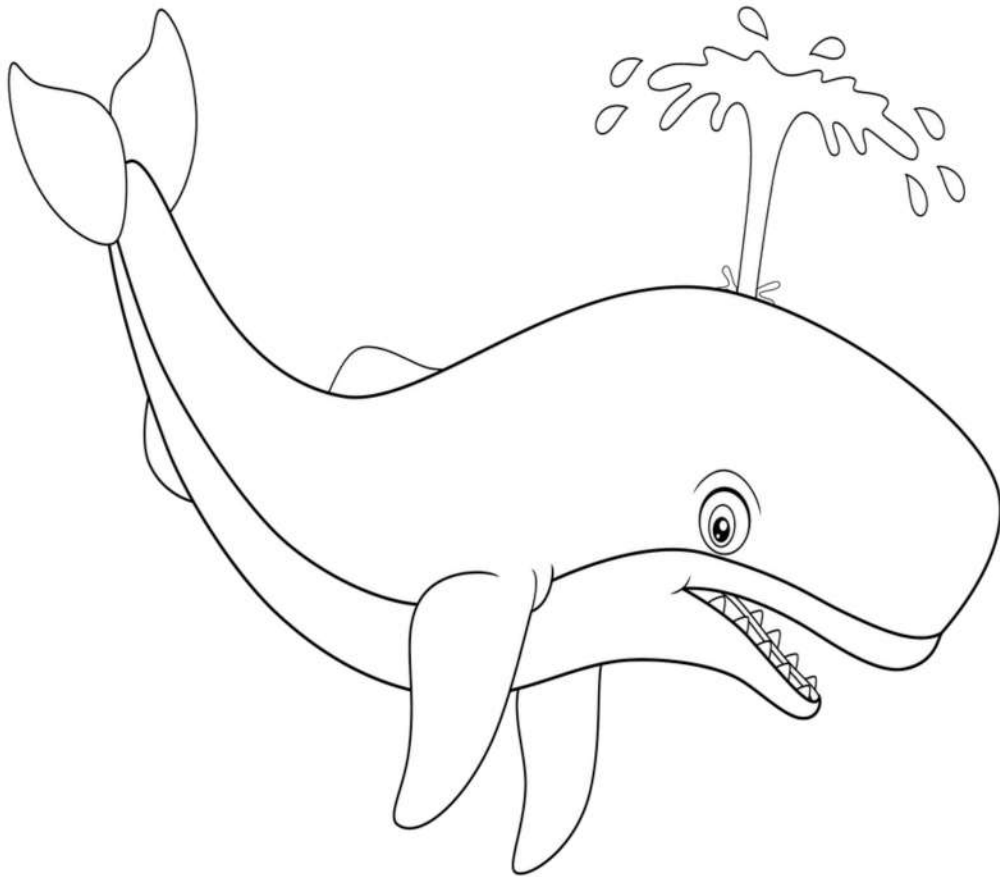

Ballena

(english name)

Write the names of the animals in english

Cc



Cocodrilo

(english name)

Write the names of the animals in english

Dd

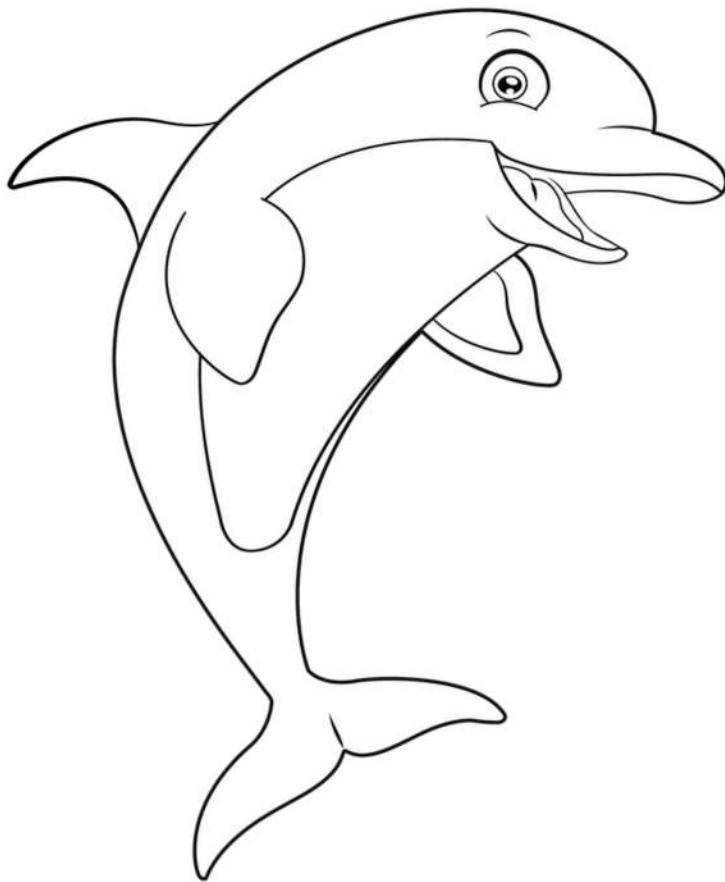

Delfín

(english name)

Write the names of the animals in english

Ee

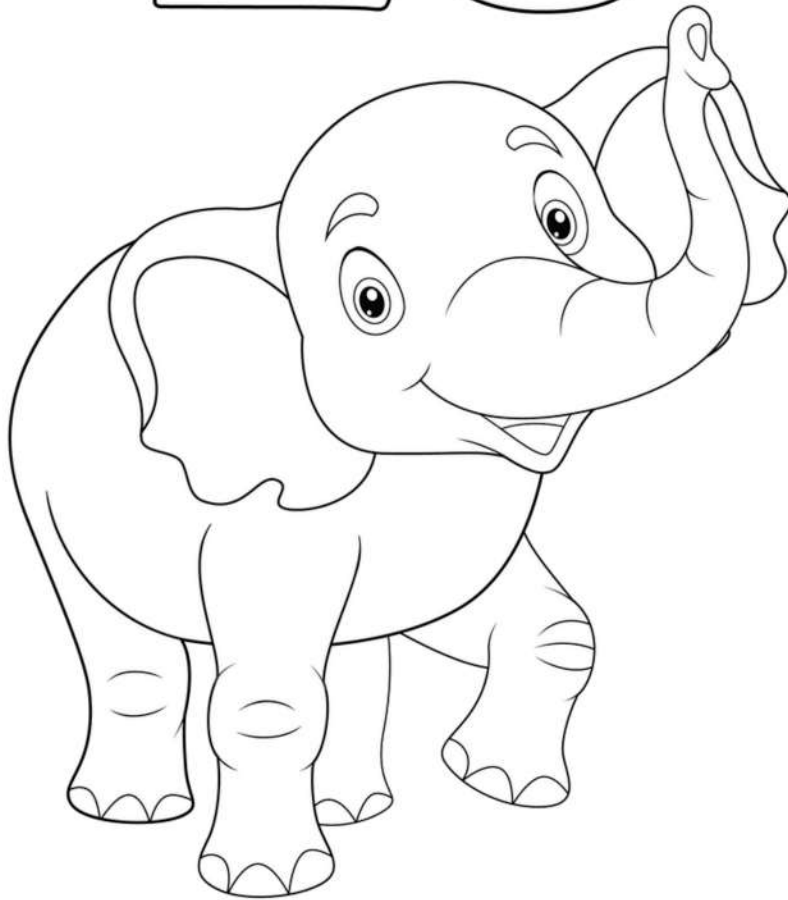

Elefante

(english name)

Write the names of the animals in english

Ff

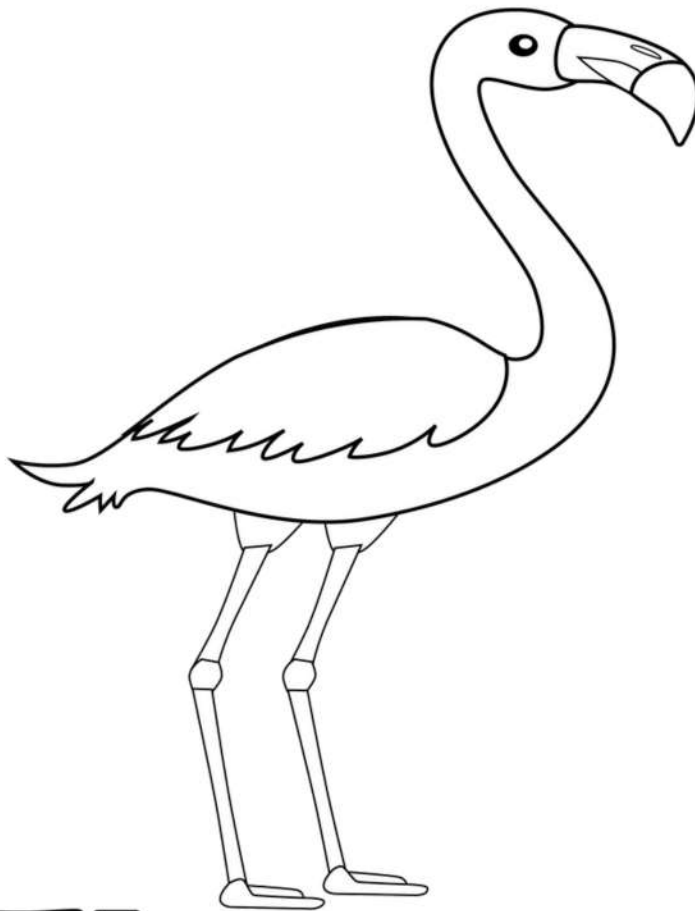

Flamenco

(english name)

Write the names of the animals in english

Gg

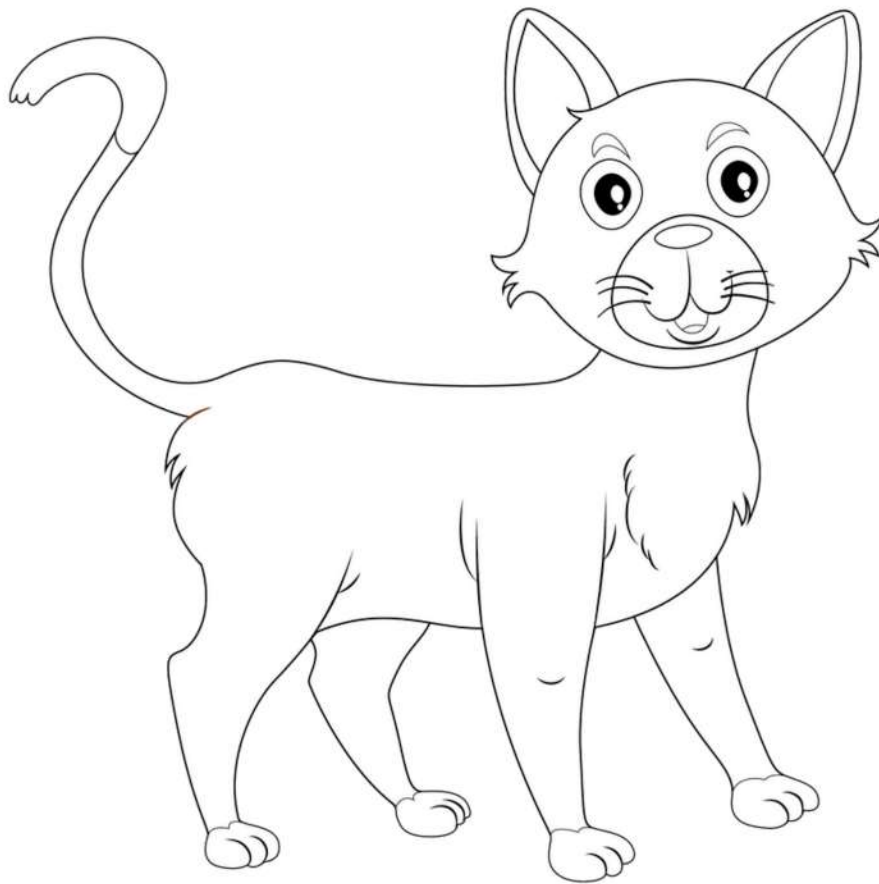

Gato

(english name)

Write the names of the animals in english

Hh

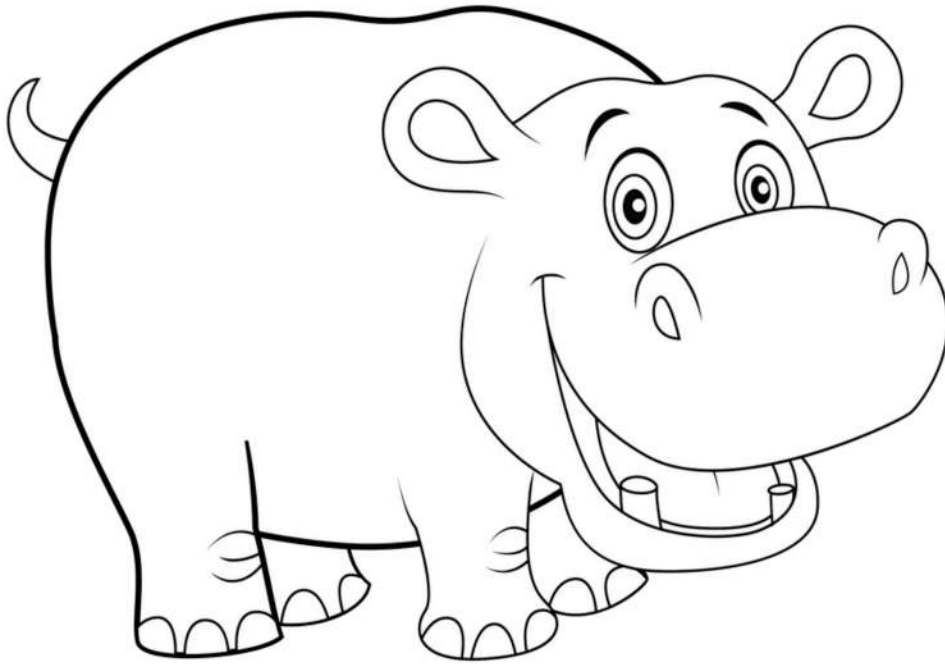

Hipopótamo

(english name)

DIVERTI

LANDIA

Write the names of the animals in english

i i



Impala

(english name)

Write the names of the animals in english

Jj

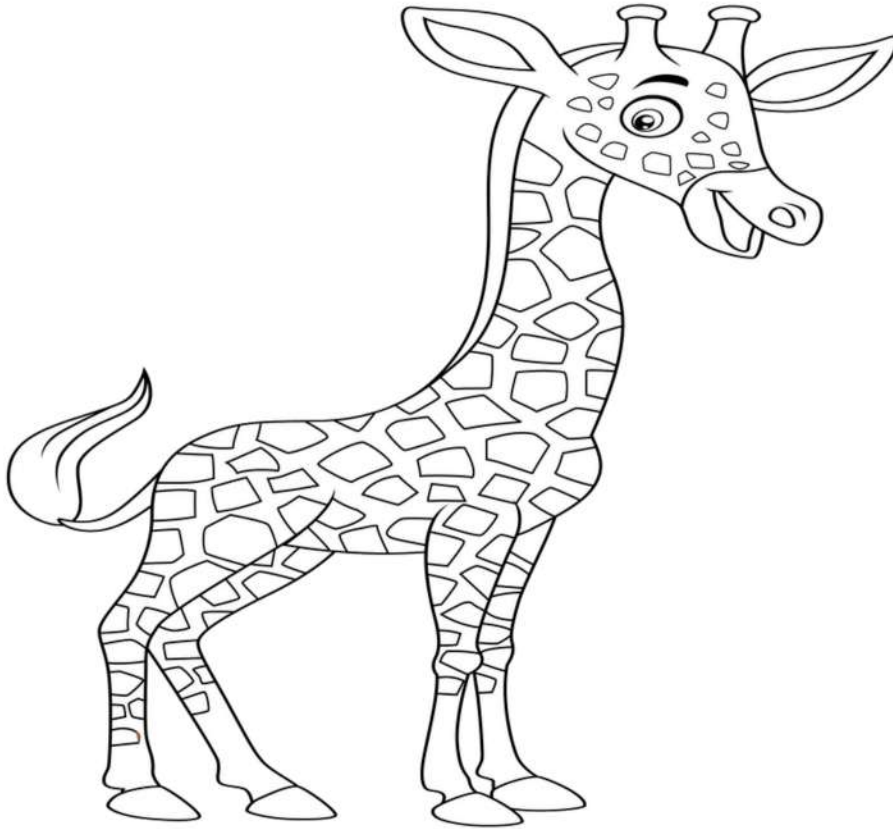

Jirafa

(english name)

Write the names of the animals in english

KK



Koala

(english name)

Write the names of the animals in english

LI



León

(english name)

Write the names of the animals in english

Mm

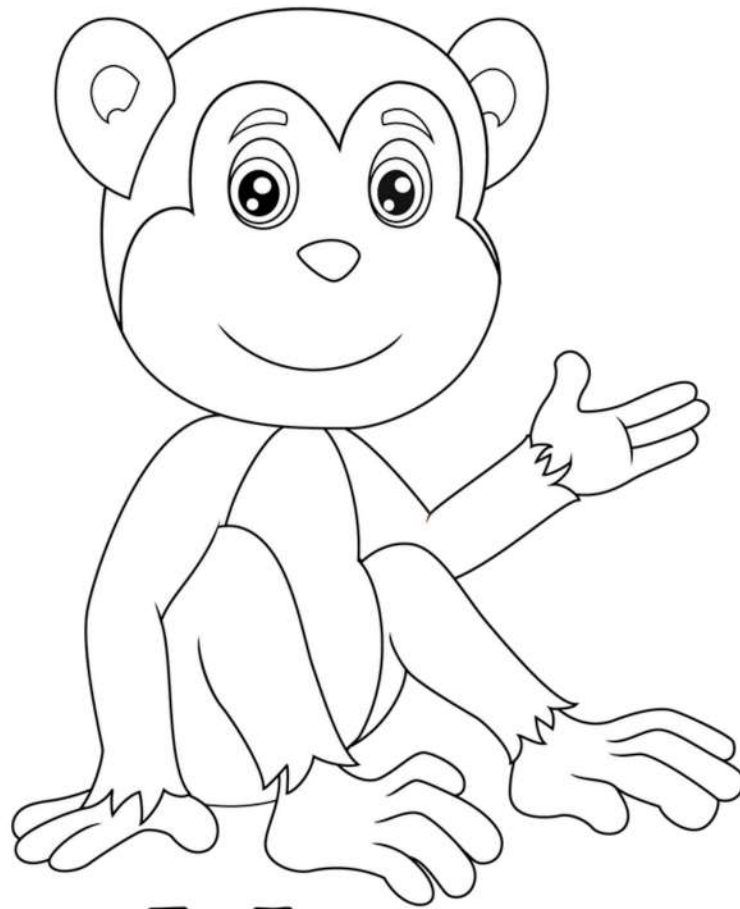

Mono

(english name)

Write the names of the animals in english

Nn



Nandou

(english name)

Write the names of the animals in english

Ñ ñ

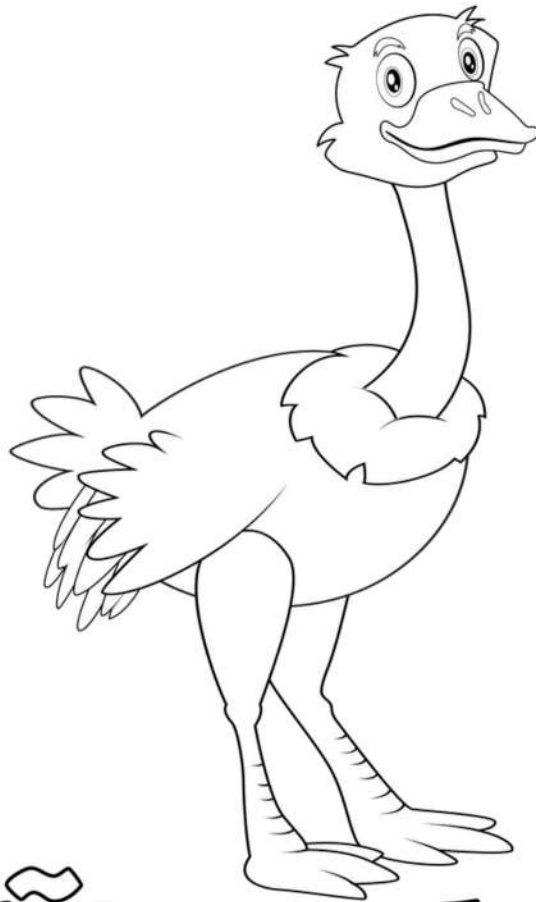

Ñandú

(english name)

Write the names of the animals in english

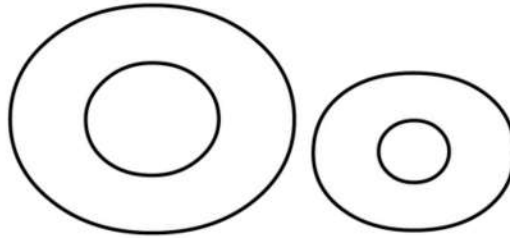

Oso

(english name)

Write the names of the animals in english

Pp



Pingüino

(english name)

Write the name in english

Q q



Queso

(english name)

Write the names of the animals in english

Rr



Rana

(english name)

Write the names of the animals in english

Ss



Serpiente

(english name)

Write the names of the animals in english

Tt

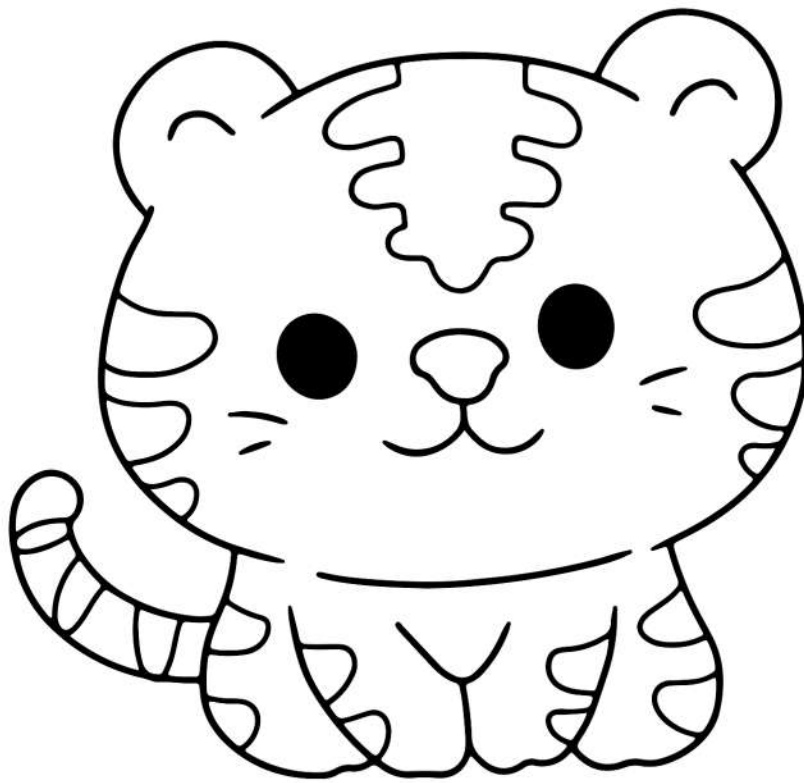

Tigre

(english name)

Write the names of the animals in english

U u



Unicornio

(english name)

Write the names of the animals in english

V v

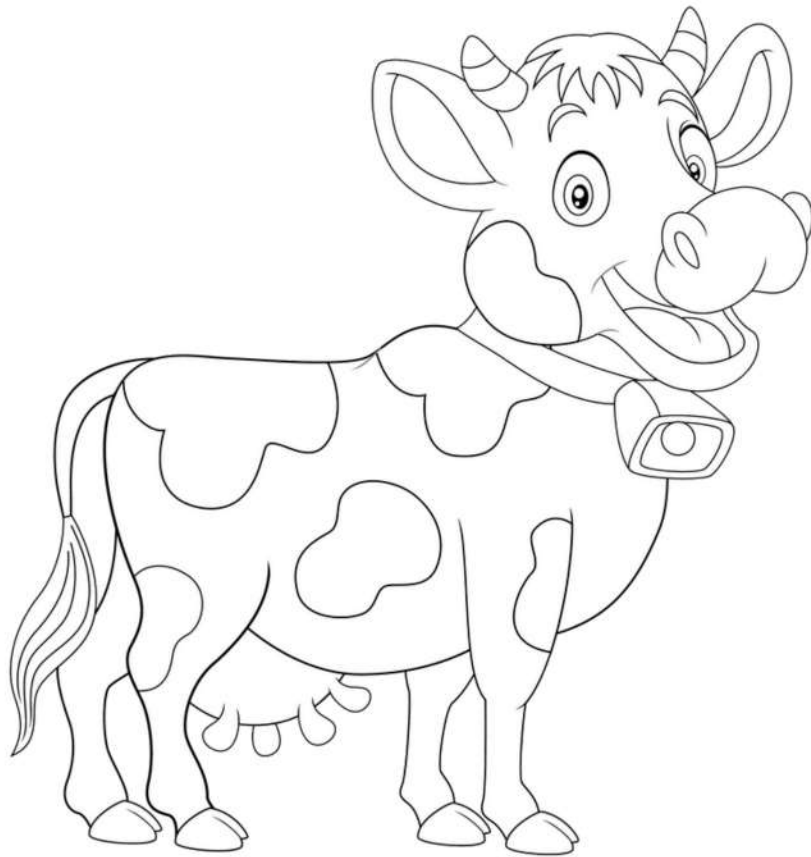

Vaca

(english name)

Spanish Workbook

Write the names of the animals in english

W w

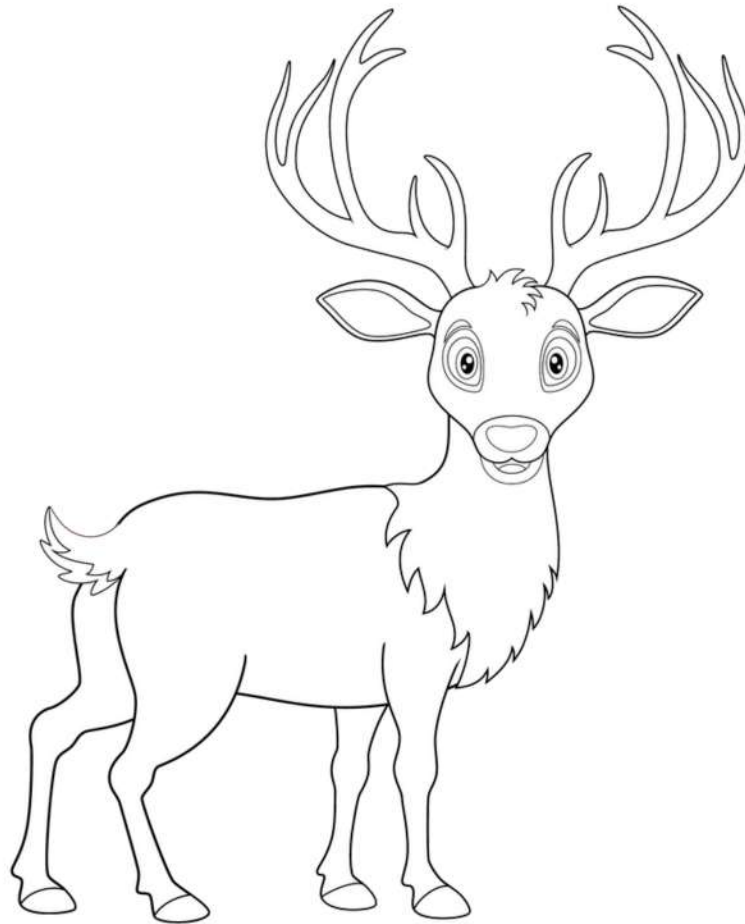

Wapití

(english name)

Write the names of the animals in english

X x

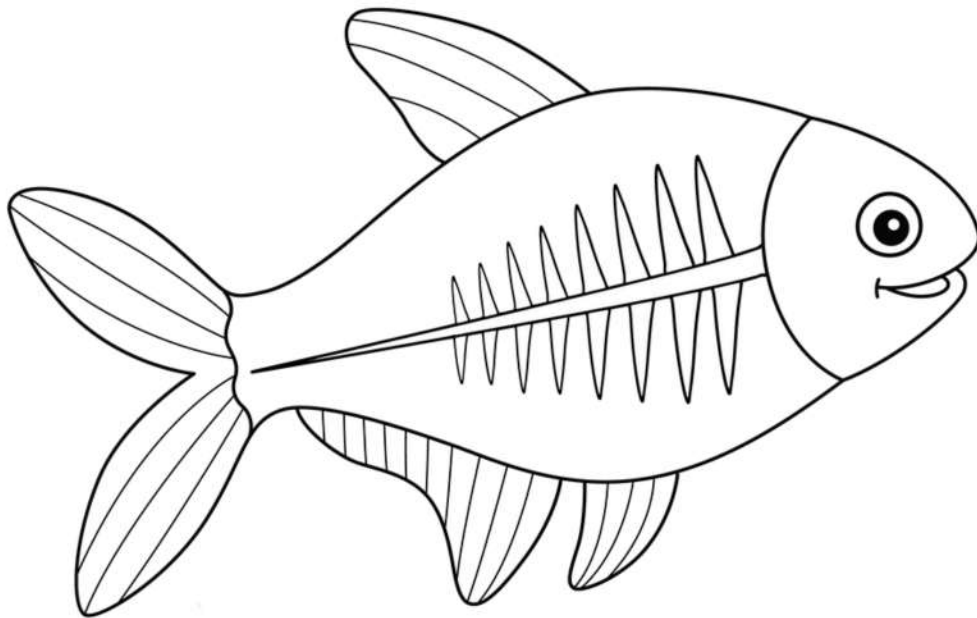

pez de rayos X

(english name)

Write the names of the animals in english

Y y

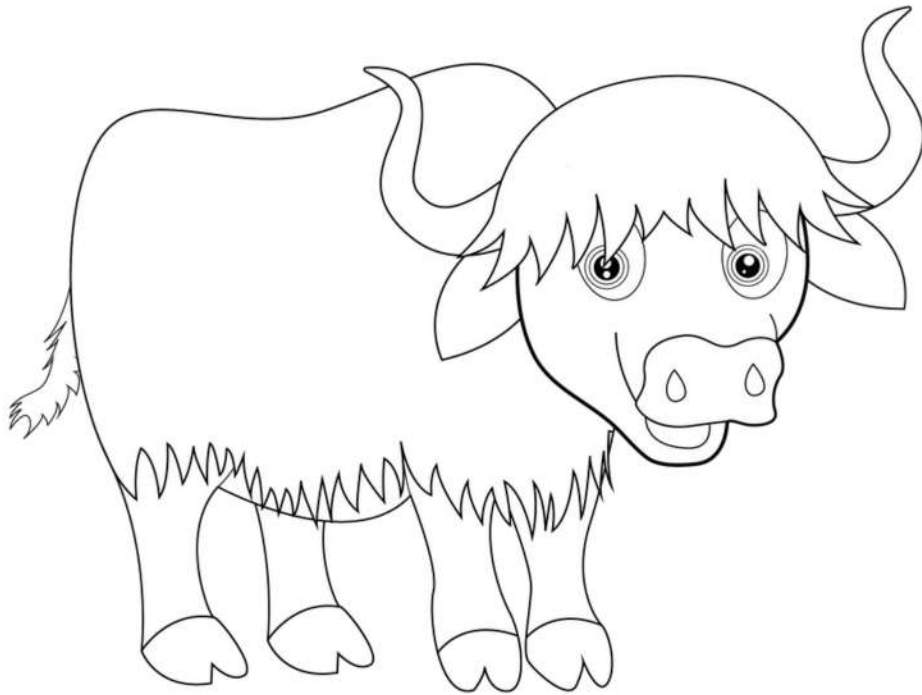

YAK

(english name)

Write the names of the animals in english

Zz

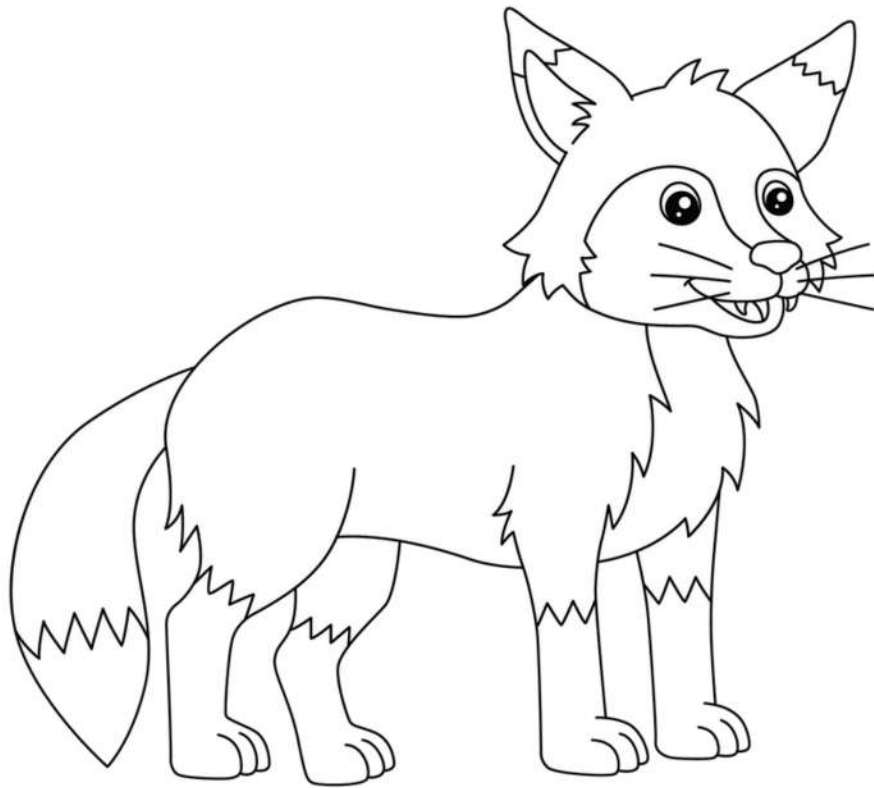

Zorro

(english name)

Spanish Workbook

Respuestas | Answers

- | | |
|--------------------|----------------|
| 1. Ardilla | 1. Squirrel |
| 2. Ballena | 2. Whale |
| 3. Cocodrilo | 3. Crocodile |
| 4. Delfin | 4. Dolphin |
| 5. Elefante | 5. Elephant |
| 6. Flamenco | 6. Flemish |
| 7. Gato | 7. Cat |
| 8. Hipopotamo | 8. Hippo |
| 9. Impala | 9. Impala |
| 10. Jirafa | 10. Giraffe |
| 11. Koala | 11. Koala |
| 12. León | 12. Lion |
| 13. Mono | 13. Bun |
| 14. Nandou | 14. Nandou |
| 15. Ñandú | 15. Rhea |
| 16. Oso | 16. Bear |
| 17. Pinguino | 17. Penguin |
| 18. Queso | 18. Cheese |
| 19. Rana | 19. Frog |
| 20. Serpiente | 20. Snake |
| 21. Tigre | 21. Tiger |
| 22. Unicornio | 22. Unicorn |
| 23. Vaca | 23. Cow |
| 24. Wapití | 24. elk |
| 25. Pez de rayos x | 25. x ray fish |
| 26. Yak | 26. Yak |
| 27. Zorro | 27. Fox |

DIVERTI

LANDIA